	GLOBAL STANDARD	Page 1 of 51
	LOW VOLTAGE UNDERGROUND CABLES WITH RATED VOLTAGE $U_0/U(U_m)$ 0,6/1,0 (1,2) kV	GSC002 Rev. 05 11/2018

LV UNDERGROUND CABLES

Countries I&N	Elaborated by
Argentina	C. Espinoza
Brazil	R. Alves
Chile	D. Gonzalez
Colombia	J. C. Gomez
Italy	L. Giansante
Peru	R. Sanchez
Romania	V. Obrejan
Spain	J. Gonzalez

	Elaborated by	Verified by	Approved by
Global I&N – O&M/NCS	J. Goossens	N. Cammalleri	M. Mazzotti

This document is intellectual property of ENEL Group distribution companies; reproduction or distribution of its contents in any way or by any means whatsoever is subject to the prior approval of the above mentioned companies which will safeguard their rights under the civil and penal codes. This document is for Internal Use.

Revision	Data	List of modifications
00	30/01/2014	First emission
01	30/11/2014	Second emission
02	19/02/2015	Third emission
03	03/12/2017	Updated common list
04	15/01/2018	Forth emission Cable Type Optimization Addition of CPR requirements Addition of technical check-list Optimization of common list
05	11/2018	Country codes included in the Common list

	GLOBAL STANDARD	Page 2 of 51
	LOW VOLTAGE UNDERGROUND CABLES WITH RATED VOLTAGE $U_0/U(U_m)$ 0,6/1,0 (1,2) kV	GSC002 Rev. 05 11/2018

INDEX

1	SCOPE	4
2	LIST OF COMPONENTS – COMMON LIST	4
3	REFERENCE LAWS AND STANDARDS.....	4
3.1	Laws.....	4
3.2	European & International Standards	5
3.3	Local Standards	7
3.4	Replaced Local Standards	7
4	CABLES CLASSIFICATIONN.....	7
5	DESIGN AND MANUFACTURING	9
5.1	Conductor	9
5.2	Insulation	10
5.3	Outer Sheath.....	11
5.4	Constructive aspects.....	11
5.5	Ampacity and Short-circuit rating	11
5.6	Marking and designation of the cable	12
	5.6.1 Cable designation.....	12
	5.6.2 Marking	12
6	TEST CLASSIFICATION	12
6.1	Acceptance tests	12
	6.1.1 Routine tests:	12
	6.1.2 Sample test.....	12
	6.1.3 Sampling and acceptance criteria	12
6.2	Type test	13
6.3	Tests list for Type I and Type II cables	14
7	GUARANTEE.....	18

	GLOBAL STANDARD	Page 3 of 51
	LOW VOLTAGE UNDERGROUND CABLES WITH RATED VOLTAGE $U_0/U(U_m)$ 0,6/1,0 (1,2) kV	GSC002 Rev. 05 11/2018

8	CONDITIONS OF SUPPLY.....	18
9	TECHNICAL CHECK-LIST	19
	LOCAL SECTION A - E-DISTRIBUZIONE (ITALY) AND E-DISTRIBUTIE (ROMANIA)	24
	LOCAL SECTION B - ENDESA DISTRIBUCIÓN ELÉCTRICA (SPAIN)	30
	LOCAL SECTION C- LATAM	37

	GLOBAL STANDARD	Page 4 of 51
	LOW VOLTAGE UNDERGROUND CABLES WITH RATED VOLTAGE $U_0/U(U_m)$ 0,6/1,0 (1,2) kV	GSC002 Rev. 05 11/2018

1 SCOPE

The aim of this document is to provide technical requirements for the supply of underground low voltage cables to be used in the distribution networks in Enel Group Distribution Companies, listed below:

<i>Codensa</i>	<i>Colombia</i>
<i>Enel distribución Perú</i>	<i>Perú</i>
<i>Edesur</i>	<i>Argentina</i>
<i>e-distributie Banat</i>	<i>Romania</i>
<i>e-distributie Dobrogea</i>	<i>Romania</i>
<i>e-distributie Muntenia</i>	<i>Romania</i>
<i>e-distribuzione</i>	<i>Italy</i>
<i>Endesa Distribución Eléctrica</i>	<i>Spain</i>
<i>Enel distribución Chile</i>	<i>Chile</i>
<i>Enel Distribuição Ceará</i>	<i>Brazil</i>
<i>Enel Distribuição Rio</i>	<i>Brazil</i>
<i>Enel Distribuição Goiás</i>	<i>Brazil</i>

This standard specifies the construction, dimensions and test requirements that must be accomplished by underground low voltage distribution cables with rated voltage $U_0/U(U_{max})=0,6/1(1,2)$ kV used in distribution systems by the utilities mentioned above.

This standard replaces all the local standards used up to now by all the Distribution Companies, as long as local regulation allows it.

2 LIST OF COMPONENTS – COMMON LIST

The list of components with the main requirements, which is an integral part of the present document, is reported attached at the end of the document.

3 REFERENCE LAWS AND STANDARDS

3.1 Laws

Brazil

- NR-10 - Segurança em Instalações e Serviços em Eletricidade

Chile

- NSEG 5 En.71 Reglamento de Instalaciones Eléctricas de Corrientes Fuertes.

Colombia

- RETIE, Reglamento Técnico de Instalaciones Eléctricas.

	GLOBAL STANDARD	Page 5 of 51
	LOW VOLTAGE UNDERGROUND CABLES WITH RATED VOLTAGE $U_0/U(U_m)$ 0,6/1,0 (1,2) kV	GSC002 Rev. 05 11/2018

- Código Eléctrico Colombiano, NTC 2050

Peru

- Código Nacional de Electricidad – Suministro 2011.
- Norma Técnica de Calidad de los servicios eléctricos (NTCSE)

Romania

- NTE007/08/00 Normativ pentru proiectare și executarea rețelelor de cabluri electrice

Spain

- R.D. 614/2001, de 8 de junio, sobre disposiciones mínimas para la protección de la salud y seguridad de los trabajadores frente al riesgo eléctrico.
- REAL DECRETO 842/2002, de 2 de agosto, por el que se aprueba el Reglamento Electrotécnico para Baja Tensión e Instrucciones Técnicas Complementarias (R.E.B.T.)
- R.D. 337/2014, de 9 de mayo, por el que se aprueban el Reglamento sobre condiciones técnicas y garantías de seguridad en instalaciones eléctricas de alta tensión y sus Instrucciones Técnicas Complementarias ITC-RAT 01 a 23.
- Reglamento (UE) nº 305/2011 del Parlamento Europeo y del Consejo, de 9 de marzo de 2011, por el que se establecen condiciones armonizadas para la comercialización de productos de construcción y se deroga la Directiva 89/106/CEE del Consejo.

3.2 European & International Standards

- EN13501-6 “Fire classification of construction products and building elements - Part 6: Classification using data from reaction to fire tests on electric cables”.
- EN 50575 “Power, control and communication cables - Cables for general applications in construction works subject to reaction to fire requirements”
- HD 603 “Distribution cables of rated voltage 0,6/1 kV”
- HD 605 “Electric cables - Additional test methods”
- IEC 60228: “Conductors of insulated cables”
- IEC 60410: Sampling plans and procedures for inspection by attributes.
- IEC 60502-1:” Power cables with extruded insulation and their accessories for rated voltages from 1 kV up to 30 kV – Part 1: cables for rated voltages of 1 kV and 3 kV”
- IEC 60332-1-2 “Tests on electric and optical fibre cables under fire conditions Part 1-2: Test for vertical flame propagation for a single insulated wire or cable - Procedure for 1 kW pre-mixed flame”
- IEC 60754-1 “Test on gases evolved during combustion of materials from cables - Part 1: Determination of the halogen acid gas content”
- IEC 60754-2 “Test on gases evolved during combustion of materials from cables - Part 2: Determination of acidity (by pH measurement) and conductivity”

	GLOBAL STANDARD	Page 6 of 51
	LOW VOLTAGE UNDERGROUND CABLES WITH RATED VOLTAGE $U_0/U(U_m)$ 0,6/1,0 (1,2) kV	GSC002 Rev. 05 11/2018

- IEC 60811-100 “Electric and optical fibre cables - Test methods for non-metallic materials-Part 100: General”
- IEC 60811-201 “Electric and optical fibre cables - Test methods for non-metallic materials-Part 201: General tests - Measurement of insulation thickness”
- IEC 60811-202 “Electric and optical fibre cables - Test methods for non-metallic materials-Part 202: General tests - Measurement of thickness of non-metallic sheath”
- IEC 60811-203 “Electric and optical fibre cables - Test methods for non-metallic materials-Part 203: General tests - Measurement of overall dimensions”
- IEC 60811-401 “Electric and optical fibre cables - Test methods for non-metallic materials-Part 401: Miscellaneous tests - Thermal ageing methods - Ageing in an air oven”
- IEC 60811-402 “Electric and optical fibre cables - Test methods for non-metallic materials-Part 402: Miscellaneous tests - Water absorption tests”
- IEC 60811-403 “Electric and optical fibre cables - Test methods for non-metallic materials-Part 403: Miscellaneous tests - Ozone resistance tests on cross-linked compounds”
- IEC 60811-409 “Electric and optical fibre cables - Test methods for non-metallic materials Part 409: Miscellaneous tests - Loss of mass test for thermoplastic insulations and sheaths
- IEC 60811-501 “Electric and optical fibre cables - Test methods for non-metallic materials-Part 501: Mechanical tests - Tests for determining the mechanical properties of insulating and sheathing compounds”
- IEC 60811-502 “Electric and optical fibre cables - Test methods for non-metallic materials Part 502: Mechanical tests - Shrinkage test for insulations”
- IEC 60811-503 “Electric and optical fibre cables - Test methods for non-metallic materials Part 503: Mechanical tests - Shrinkage test for sheaths”
- IEC 60811-504 “Electric and optical fibre cables - Test methods for non-metallic materials-Part 504: Mechanical tests - Bending tests at low temperature for insulation and sheaths”
- IEC 60811-505 “Electric and optical fibre cables - Test methods for non-metallic materials-Part 505: Mechanical tests - Elongation at low temperature for insulations and sheaths”
- IEC 60811-506 “Electric and optical fibre cables - Test methods for non-metallic materials-Part 506: Mechanical tests - Impact test at low temperature for insulations and sheaths”
- IEC 60811-507 “Electric and optical fibre cables - Test methods for non-metallic materials-Part 507: Mechanical tests - Hot set test for cross-linked materials”
- IEC 60811-508 “Electric and optical fibre cables - Test methods for non-metallic materials Part 508: Mechanical tests - Pressure test at high temperature for insulation”
- and sheaths
- IEC 60811-605 “Electric and optical fibre cables - Test methods for non-metallic materials-Part 605: Physical tests - Measurement of carbon black and/or mineral filler in polyethylene compounds”

	GLOBAL STANDARD	Page 7 of 51
	LOW VOLTAGE UNDERGROUND CABLES WITH RATED VOLTAGE $U_0/U(U_m)$ 0,6/1,0 (1,2) kV	GSC002 Rev. 05 11/2018

- IEC 61034-2 “Measurement of smoke density of cables burning under defined conditions - Part 2: Test procedure and requirements”
- IEC 62230 “Electric cables - Spark-test method”
- ISO 2859-0 “Sampling procedures for inspection by attributes -- Part 0: Introduction to the ISO 2859 attribute sampling system”
- ISO 2859-1 “Sampling procedures for inspection by attributes -- Part 1: Sampling schemes indexed by acceptance quality limit (AQL) for lot-by-lot inspection”

3.3 Local Standards

See Local Section.

3.4 Replaced Local Standards

See Local Section.

4 CABLES CLASSIFICATION

The typical layout of a single core cable is shown in Figure 1, in Figure 2 a preassembled 4-core cable is shown. The different parts of the cables are depicted in section 5.

In Table 1 Types of cables specified in this document are briefly depicted.

TYPE	DESCRIPTION
I	Unipolar cable with aluminum conductor, cross-linked polyethylene insulation (XLPE) and polyolefin (PO) outer sheath. Class E_{ca} according to EN 50575*
II	Helically bundled tetra polar cable with aluminum conductor, cross-linked polyethylene insulation (XLPE) and polyolefin (PO) outer sheath. Class E_{ca} according to EN 50575*
*Only European cables	

Table 1 Types of cables

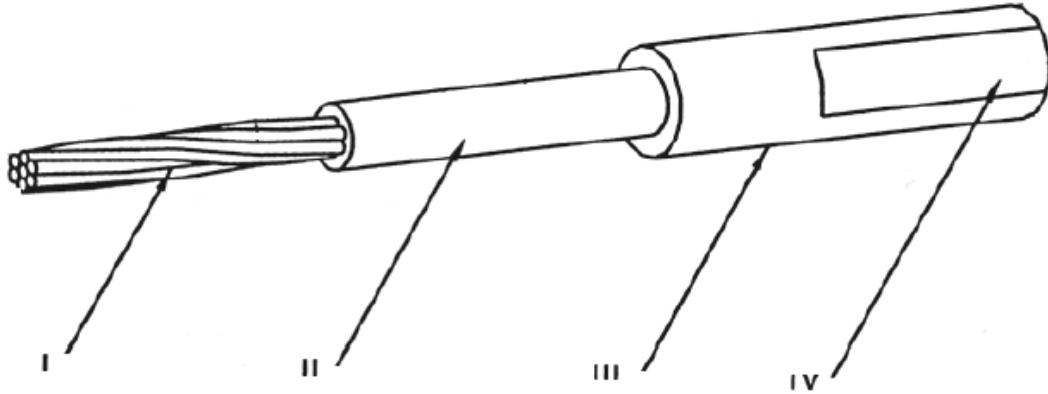

I – Conductor
II – Insulation
III – Outer Sheath
IV – Marking
Figure 1: Schematic drawing of Type I cables

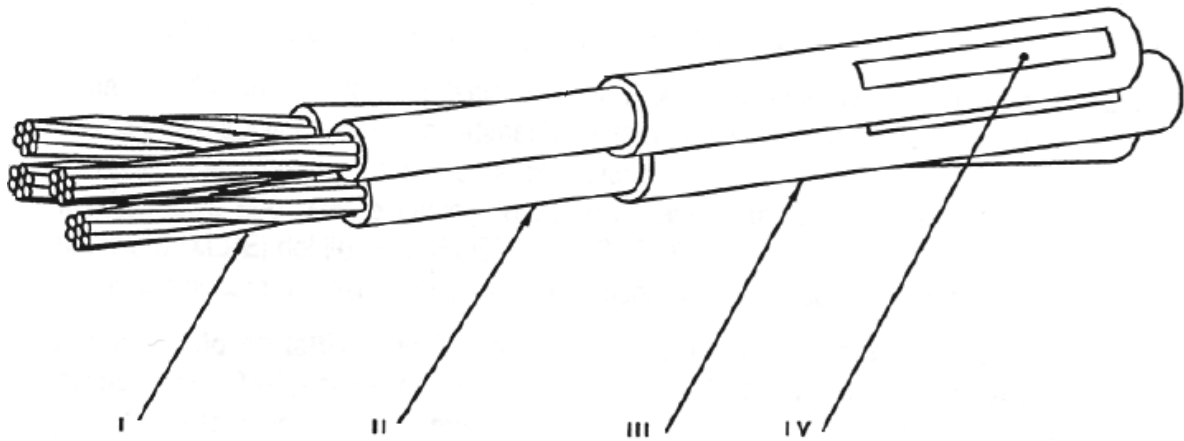

I – Conductor
II – Insulation
III – Outer Sheath
IV – Marking
Figure 2: Schematic drawing of Type II cable

Note: Figures are for illustrative purposes only.

	GLOBAL STANDARD	Page 9 of 51
	LOW VOLTAGE UNDERGROUND CABLES WITH RATED VOLTAGE $U_0/U(U_m)$ 0,6/1,0 (1,2) kV	GSC002 Rev. 05 11/2018

5 DESIGN AND MANUFACTURING

5.1 Conductor

For Type I and Type II cables the aluminum conductors shall be stranded compacted circular class 2, complying all the features specified herein and in standard IEC 60228. The conductor material shall be AA-1350 i.e. 99,5% aluminum content.

For **Codensa** cables the conductor material shall be AA-8000 series.

In Table 2 aluminum conductors main features are depicted.

Nominal cross-section [mm ²]	Minimum number of wires	Diameter of conductors [mm]		Maximum resistance of conductor at 20°C [Ω/km]
		Minimum	Maximum	
10	6	3,6	4,2	3,08
16	6	4,6	5,2	1,91
25	6	5,6	6,5	1,20
35	6	6,6	7,5	0,868
50	6	7,7	8,6	0,641
70	12	9,3	10,2	0,443
95	15	11,0	12,0	0,320
150	15	13,7	15,0	0,206
240	30	17,6	19,2	0,125

Table 2 Aluminum conductors characteristics according to IEC 60228.

	GLOBAL STANDARD	Page 10 of 51
	LOW VOLTAGE UNDERGROUND CABLES WITH RATED VOLTAGE $U_0/U(U_m)$ 0,6/1,0 (1,2) kV	GSC002 Rev. 05 11/2018

5.2 Insulation

The insulation shall be applied by a suitable extrusion process, and shall form a compact and homogenous body. In addition, it shall be possible to remove without creating any damage to the conductor.

The insulating material shall be cross-linked polyethylene; compliant with the characteristics required herein. The XLPE insulation must allow maximum conductor temperatures of 90 °C in normal operation and 250 °C under short circuit condition by at least 5 seconds.

The minimum thickness of insulation measured and accepted at any point of the cable shall not be less than 90% of the nominal value minus 0,1 mm. In addition, the average of all these measures should not be less than the nominal thickness.

$$t_{min} \geq 0,9 t_n - 0,1$$

Where:

t_{min} : minimum insulation thickness in millimeters

t_n : nominal thickness in millimeters

In Table 3 nominal and minimum thickness for XLPE insulated cables are shown.

Cross-section [mm ²]	Insulation nominal thickness [mm]	Insulation minimum thickness [mm]
10	0,7	0,53
16	0,7	0,53
25	0,9	0,71
35	0,9	0,71
50	1	0,80
70	1,1	0,89
95	1,1	0,89
150	1,4	1,16
240	1,7	1,43

Table 3 XLPE insulation thickness

The cross-linked polyethylene insulation material shall be colorless (natural).

	GLOBAL STANDARD	Page 11 of 51
	LOW VOLTAGE UNDERGROUND CABLES WITH RATED VOLTAGE $U_0/U(U_m)$ 0,6/1,0 (1,2) kV	GSC002 Rev. 05 11/2018

5.3 Outer Sheath.

The outer sheath shall be resistant to moisture, abrasion and UV. In addition, it shall be free from heavy metals or volatile hydrocarbons.

The outer sheath material shall be polyolefin compliant with the characteristics required herein.

The outer sheath shall be adhered to the insulation.

The minimum thickness of the outer sheath measured and accepted at any point of the cable shall not be less than 85% of the nominal value minus 0,1 mm. In addition, the average of all these measures should not be less than the nominal thickness.

$$t_{min} \geq 0,85 t_n - 0,1$$

Where:

t_{min} : minimum thickness in millimeters

t_n : nominal thickness in millimeters

In Table 4 nominal and minimum thickness of the polyolefin outer sheath of Type I and Type II cables are shown.

Cross-section [mm ²]	Sheath nominal thickness [mm]	Sheath minimum thickness [mm]
10	1,3	1,01
16	1,3	1,01
25	1,3	1,01
35	1,3	1,01
50	1,3	1,01
70	1,4	1,01
95	1,4	1,09
150	1,4	1,09
240	1,5	1,18

Table 4 PO outer sheath thickness

Unless otherwise indicated in the local sections the outer sheath color shall be black.

5.4 Constructive aspects.

For Type II cables the cores shall be bundled in anticlockwise sense, with a pitch equal to (80 ± 8) times the maximum value specified for diameter D of the phase cores.

5.5 Ampacity and Short-circuit rating

See local section.

	GLOBAL STANDARD	Page 12 of 51
	LOW VOLTAGE UNDERGROUND CABLES WITH RATED VOLTAGE $U_0/U(U_m)$ 0,6/1,0 (1,2) kV	GSC002 Rev. 05 11/2018

5.6 Marking and designation of the cable

5.6.1 Cable designation

See Local Section.

5.6.2 Marking

The marking must be indelible paint, easily legible and carried out by engraving or in relief above the surface of the outer sheath in a continuous way.

Specific characteristics are detailed in Local Section.

6 TEST CLASSIFICATION

6.1 Acceptance tests

Acceptance tests (routine tests and sample tests) shall be carried out in the Supplier's facilities.

6.1.1 Routine tests:

Routine tests shall be performed at 100% of delivered spools

6.1.2 Sample test

Sample tests are carried out over samples taken from a complete cable (See Table 5 in sub-clause 6.1.3 for sampling).

6.1.3 Sampling and acceptance criteria

In order to determine acceptability of a lot, an inspection by attributes following a simple sampling plan shall be performed, in compliance with standard ISO 2859-0 and ISO 2859-1.

Specifically, AQL=1,5%, level II, rejecting any "minor, major or critical" defect in the inspection.

The costs of rejected materials will be charged to the bidder. The approval or rejection of each one of the samples will be according to what is required in standard ISO 2859-1 for each one of the trials.

In detail, if a lot doesn't comply with what is required in the electric resistance test according to the approval requirements of the reference standard, the Inspector can carry out such test to all the units that make up the lot. If only a single spool is purchased, it must be tested according to what is indicated for a single sample.

	GLOBAL STANDARD	Page 13 of 51
	LOW VOLTAGE UNDERGROUND CABLES WITH RATED VOLTAGE $U_0/U(U_m)$ 0,6/1,0 (1,2) kV	GSC002 Rev. 05 11/2018

Amount of reels	Numbers of samples	Acceptable Level	Rejection Level
2 - 8	2	0	1
9 - 15	3	0	1
16 - 25	5	0	1
26 - 50	8	0	1
51 - 90	13	0	1
91 - 150	20	1	2
151 - 280	32	1	2
281 - 500	50	2	3
501 - 1200	80	3	4
1201 - 3200	125	5	6
3201 - 10000	200	7	8
>10000	315	10	11

Table 5: Samples and Grade of Acceptance to Each of the Trials

6.2 Type test

Type tests shall be performed before supplying a type of cable covered by this standard in order to demonstrate satisfactory performance characteristics to meet the intended application.

When type tests have been successfully performed on one type cable covered herein with a specific cross-section and construction characteristics, the type approval shall be accepted as valid for as long as the following conditions are met:

- a) The conductor cross-section is not larger than that of the tested cable.
- b) The cable as similar constructions as that of the tested cable, i.e utilizes same materials, (conductor, insulation, outer sheath) and the same manufacturing process.

When the design, materials or manufacturing process are changed (which might affect the performance characteristics of the cable), the relevant type tests shall be repeated.

Cables shall undergo type tests and acceptance tests for type approval

	GLOBAL STANDARD	Page 14 of 51
	LOW VOLTAGE UNDERGROUND CABLES WITH RATED VOLTAGE $U_0/U(U_m)$ 0,6/1,0 (1,2) kV	GSC002 Rev. 05 11/2018

6.3 Tests list for Type I and Type II cables

N°	Test	Requirements	Test Method	R	S	T
1	Conductor electrical resistance	See clause 5	IEC 60502-1 sub-clause 15.2	X	-	-
2	Spark test during manufacturing	No breakdown	IEC 62230	X	-	-
3	Conformity to the approved type	See clause 5	Constructional characteristics, markings colors, and phase identification shall be inspected by visual examination. Dimensions, thickness, pitches and diameters shall be measured according to IEC 60811 parts 201, 202 and 203.	-	X	-
4	Verification of the length declared by the supplier	On one of the cable sizes on which the conductor electrical resistances is verified, it must be checked, by measurement, that the finished cable length is not shorter than that declared by the Supplier by more than 0,5 m. In the case the verification result is negative, it must be continued on other sizes to execute a statistical control for attributes on sample as described in the ISO 2859/93 standard, adopting the simple sampling plan, ordinary inspection and acceptable quality level 2,5%, general inspection I		-	X	-
5	XLPE Mechanical properties Before ageing on sample Minimum tensile strength Minimum elongation at break	12,5 MPa 200%	IEC 60811-501	-	-	X
6	XLPE Hot set test Temperature Duration Mechanical stress Maximum elongation under load Maximum residual elongation	200 °C 15 min 0,2 MPa 175% 15%	IEC 60811-507	-	X	-
7	XLPE mechanical properties After ageing on sample Temperature Duration T1 Minimum Tensile strength Maximum variation T1/T0 Minimum elongation at break Maximum variation T1/T0	135 °C 168 h ±25% ±25%	IEC 60811-501 IEC 60811-401	-	-	X



N°	Test	Requirements	Test Method	R	S	T
8	Insulation resistance at 90 °C Volume resistivity [$\Omega \cdot \text{cm}$] Insulation constant K_i [$M\Omega \cdot \text{km}$]	10 ¹² 3,67	IEC 60502-1 sub-clause 17.2	-	-	X
9	XLPE Water absorption test (Gravimetric method) Temperature Duration Maximum variation of mass For density $\leq 1,02$ g/ml For density $> 1,02$ g/ml	85 °C 336 h 1 mg/cm ² 5 mg/cm ²	IEC 60811-402	-	-	X
10	XLPE Shrinkage test Duration Temperature Maximum shrinkage	1 h 130 °C 4%	IEC 60811-502	-	-	X
11	PO Mechanical properties Before ageing on sample Minimum tensile strength Minimum elongation at break	12,5 MPa 300%	IEC 60811-501	-	-	X
12	PO mechanical properties After ageing on sample Temperature Duration <i>Minimum Tensile strength</i> Maximum variation T1/T0 <i>Minimum elongation at break</i> Maximum variation T1/T0	110 \pm 2 °C 168 h \pm 25% \pm 25%	IEC 60811-501 IEC 60811-401	-	-	X
13	PO pressure test at high temperature Duration Temperature Coefficient k Maximum depth of indentation	6 h 105 \pm 2 °C 0,6/0,7 50%	IEC 60811-508	-	-	X
14	PO tear resistance test Temperature Minimum resistance	20 \pm 5 °C 9 N/mm	HD 605 Sub clause 2.2.2.2	-	-	X



LOW VOLTAGE UNDERGROUND CABLES
WITH RATED VOLTAGE $U_0/U(U_m)$ 0,6/1,0 (1,2) kV

GSC002
Rev. 05
11/2018

N°	Test	Requirements	Test Method	R	S	T
15	PO test at low temperature When cable $D > 12,5$ mm Elongation test Temperature Minimum elongation When cable $D \leq 12,5$ mm Bending test Temperature	$-15 \pm 2^\circ\text{C}$ 20%	IEC 60811-505 IEC 60811-504	-	-	X
16	PO loss of mass test Temperature Duration Maximum loss of mass	$100 \pm 2^\circ\text{C}$ 168 h $0,5 \text{ mg/cm}^2$	IEC 60811-409	-	-	X
17	PO Water absorption test (Gravimetric method) Temperature Duration Maximum variation of mass	$85 \pm 2^\circ\text{C}$ 336 h 5 mg/cm^2	IEC 60811-402	-	-	X
18	PO Heavy metals content test Lead	$< 0,5\%$	Spectrophotometer	-	-	X
19	PO UV ray resistance test Tensile strength max variation Elongation at break max variation Decoloration	15% 15% Low	HD 605 Sub clause 2.4.23 UNE 211605 for Endesa See Local section B for conditions	-	-	X
20	PO halogen acid gas content	$\leq 5 \text{ mg/g}$	IEC 60754-1	-	-	X
21	PO gas acidity and conductivity Minimum pH Maximum conductivity	4.3 $10 \text{ }\mu\text{S/mm}$,	IEC 60754-2	-	-	X
22	Voltage Test (Manufacturing length) Test voltage Test duration Test Result	$3,5 \text{ kV AC}$ or $8,5 \text{ kV DC}$ 5 min No breakdown	IEC 60502-1 sub-clause 15.3.2	X	-	-
23	Voltage Test for 4 h (Complete cable) Test voltage Test duration Test Result	$2,4 \text{ kV}$ 4 h No breakdown	IEC 60502-1 sub-clause 17.3	-	-	X



N°	Test	Requirements	Test Method	R	S	T
24	Cold impact test (Complete cable) Temperature Test Result	-15±2 °C No cracks	IEC 60811-506	-	-	X
25	Non contamination test (Complete cable) PO Mechanical properties Temperature Duration T1 <i>Minimum elongation at break</i> Maximum variation T1/T0	110±2 °C 168 h ±25%	IEC 60811-501 IEC 60811-401	-	-	X
26	Shrinkage test (Complete cable) L Duration Temperature Maximum shrinkage	200 mm 5 x 5 h 80±2 °C 4%	IEC 60811-503	-	-	X
27	Special bending test (Complete cable)	No breakdown	HD 605 2.4.1.2	-	-	X
28	Abrasion resistance test (Complete cable) Temperature Mass (cross-section ≤120 mm ²) Mass (cross-section ≥150 mm ²) Speed Number of scratches	20±5 °C 12 kg 18 kg 0,3±15% m/s 8	HD 605 Sub-clause 2.4.22	-	-	X
29	Reaction to fire test (Complete cable)	E _{ca}	EN 50575 IEC 60332-1-2	-	-	X
30	Measurement of smoke density (Complete cable) Minimum light transmittance	60%	IEC 61034-2	-	-	X
R: Routine test S: Sample test T: Type test						

	GLOBAL STANDARD	Page 18 of 51
	LOW VOLTAGE UNDERGROUND CABLES WITH RATED VOLTAGE $U_0/U(U_m)$ 0,6/1,0 (1,2) kV	GSC002 Rev. 05 11/2018

7 GUARANTEE

Requirement of warranty will be indicated in the request for bids, including periods and standards.

8 CONDITIONS OF SUPPLY

See in Local Section.

	GLOBAL STANDARD	Page 19 of 51
	LOW VOLTAGE UNDERGROUND CABLES WITH RATED VOLTAGE $U_0/U(U_m)$ 0,6/1,0 (1,2) kV	GSC002 Rev. 05 11/2018

9 TECHNICAL CHECK-LIST

The following chart indicates the minimum technical information that suppliers shall give before the tender.

Item	Description	Unit	Required	Offered
1	GENERAL INFORMATION			
1.1	Supplier	-	Manufacturer information	Manufacturer information
1.2	Factory	-	Manufacturer information	Manufacturer information
2	MAIN FEATURES			
2.1	Distribution Company and Country	-		
2.2	Country Code	-		
2.3	GS Type Code	-		
2.4	Rated Voltage U_0/U (U_{max})	[kV]		
2.5	Disposition	[n xmm ²]		
2.6	Type I or Type II	-		
3	CONDUCTOR			
3.1	Material	-		
3.2	Nominal cross-section	[mm ²]		
3.3	Minimum Number of Wires of Conductor	-		
3.4	Minimum diameter	[mm]		
3.5	Maximum diameter	[mm]		
3.6	Maximum resistance of conductor at 20°C	[Ω/ km]		
3.7	Stranding Type	-		
4	INSULATION			
4.1	Material	-		
4.2	Nominal thickness	[mm]		
4.3	Minimum thickness	[mm]		
4.4	Color	-		
5	OUTER SHEATH			
5.1	Material	-		
5.2	Nominal thickness	[mm]		
5.3	Minimum thickness	[mm]		
5.4	Color	-		
6	ADDITIONAL FEATURES			
6.1	Maximum total diameter	[mm]		
6.2	Drum Type	-		
6.3	Total length in one drum	[m]		
6.4	Ampacity (See clause 5.5 for conditions)	[A]		
6.5	Weight per unit of length	[kg/km]		
6.6	Fire reaction Class (EN 50575 if apply)			



Item	Description	Unit	Required	Offered
7	NEUTRAL CABLES (IF TYPE II)			
7.1	CONDUCTOR			
7.1.1	Material	-		
7.1.2	Nominal cross-section	[mm ²]		
7.1.3	Minimum Number of Wires of Conductor	-		
7.1.4	Minimum diameter	[mm]		
7.1.5	Maximum diameter	[mm]		
7.1.6	Maximum resistance of conductor at 20°C	[Ω/ km]		
7.1.7	Stranding Type	-		
7.2	INSULATION			
7.2.1	Material	-		
7.2.2	Nominal thickness	[mm]		
7.2.3	Minimum thickness	[mm]		
7.2.4	Color	-		
7.3	OUTER SHEATH			
7.3.1	Material	-		
7.3.2	Nominal thickness	[mm]		
7.3.3	Minimum thickness	[mm]		
7.3.4	Color	-		

	GLOBAL STANDARD	Page 21 of 51
	LOW VOLTAGE UNDERGROUND CABLES WITH RATED VOLTAGE $U_0/U(U_m)$ 0,6/1,0 (1,2) kV	GSC002 Rev. 05 11/2018

9.1 Technical check-list examples

9.1.1 Type I 1x240 mm² cable

Item	Description	Unit	Required	Offered
1	GENERAL INFORMATION			
1.1	Supplier	-	Manufacturer information	Manufacturer information
1.2	Factory	-	Manufacturer information	Manufacturer information
2	MAIN FEATURES			
2.1	Distribution Company and Country	-	EE-SPAIN	
2.2	Country Code	-	330009	
2.3	GS Type Code	-	GSC002/006	
2.4	Rated Voltage $U_0/U(U_{max})$	[kV]	0,6/1	
2.4	Disposition	[n xmm ²]	1x240	
2.5	Type I or Type II	-	Type I	
3	CONDUCTOR			
3.1	Material	-	Aluminum	
3.2	Nominal cross-section	[mm ²]	240	
3.3	Minimum Number of Wires of Conductor	-	30	
3.4	Minimum diameter	[mm]	17,6	
3.5	Maximum diameter	[mm]	19,2	
3.6	Maximum resistance of conductor at 20°C	[Ω/ km]	0,125	
3.7	Stranding Type	-	Circular compacted class 2	
4	INSULATION			
4.1	Material	-	XLPE	
4.2	Nominal thickness	[mm]	1,7	
4.3	Minimum thickness	[mm]	1,43	
4.4	Color	-	Natural (colorless)	
5	OUTER SHEATH			
5.1	Material	-	Polyolefin DM01	
5.2	Nominal thickness	[mm]	1,5	
5.3	Minimum thickness	[mm]	1,18	
5.4	Color	-	Black	
6	ADDITIONAL FEATURES			
6.1	Maximum total diameter	[mm]	Informative	
6.2	Drum Type	-	Informative	
6.3	Total length in one drum	[m]	Informative	
6.4	Ampacity (See clause 5.5 for conditions)	[A]	Calculated value	
6.5	Weight per unit of length	[kg/km]	Informative	
6.6	Fire reaction Class (EN 50575 if apply)		Eca	

	GLOBAL STANDARD	Page 22 of 51
	LOW VOLTAGE UNDERGROUND CABLES WITH RATED VOLTAGE $U_0/U(U_m)$ 0,6/1,0 (1,2) kV	GSC002 Rev. 05 11/2018

9.1.2 Type II 3x240+150N mm² cable

Item	Description	Unit	Required	Offered
1	GENERAL INFORMATION			
1.1	Supplier	-	Manufacturer information	Manufacturer information
1.2	Factory	-	Manufacturer information	Manufacturer information
2	MAIN FEATURES			
2.1	Distribution Company and Country	-	ED-ITALY	
2.2	Country Code	-	330657	
2.3	GS Type Code	-	GSC002/006	
2.4	Rated Voltage U_0/U (U_{max})	[kV]	0,6/1	
2.4	Disposition	[n xmm ²]	3x240+150	
2.5	Type I or Type II	-	Type II	
3	CONDUCTOR			
3.1	Material	-	Aluminum	
3.2	Nominal cross-section	[mm ²]	240	
3.3	Minimum Number of Wires of Conductor	-	30	
3.4	Minimum diameter	[mm]	17,6	
3.5	Maximum diameter	[mm]	19,2	
3.6	Maximum resistance of conductor at 20°C	[Ω/ km]	0,125	
3.7	Stranding Type	-	Circular compacted class 2	
4	INSULATION			
4.1	Material	-	XLPE	
4.2	Nominal thickness	[mm]	1,7	
4.3	Minimum thickness	[mm]	1,43	
4.4	Color	-	Natural (colorless)	
5	OUTER SHEATH			
5.1	Material	-	Polyolefin	
5.2	Nominal thickness	[mm]	1,5	
5.3	Minimum thickness	[mm]	1,18	
5.4	Color	-	Black	
6	ADDITIONAL FEATURES			
6.1	Maximum total diameter	[mm]	Informative	
6.2	Drum Type	-	22 (GUI 102)	
6.3	Total length in one drum	[m]	500	
6.4	Ampacity (See clause 5.5 for conditions)	[A]	Calculated value	
6.5	Weight per unit of length	[kg/km]	Informative	
6.6	Fire reaction Class (EN 50575 if apply)		Eca	



Item	Description	Unit	Required	Offered
7	NEUTRAL CABLES (IF TYPE II)			
7.1	CONDUCTOR			
7.1.1	Material	-	Aluminum	
7.1.2	Nominal cross-section	[mm ²]	150	
7.1.3	Minimum Number of Wires of Conductor	-	15	
7.1.4	Minimum diameter	[mm]	13,7	
7.1.5	Maximum diameter	[mm]	15,0	
7.1.6	Maximum resistance of conductor at 20°C	[Ω/ km]	0,206	
7.1.7	Stranding Type	-	Compacted circular class 2	
7.2	INSULATION			
7.2.1	Material	-	XLPE	
7.2.2	Nominal thickness	[mm]	1,4	
7.2.3	Minimum thickness	[mm]	1,16	
7.2.4	Color	-	Colorless (Natural)	
7.3	OUTER SHEATH			
7.3.1	Material	-	Polyolefin	
7.3.2	Nominal thickness	[mm]	1,4	
7.3.3	Minimum thickness	[mm]	1,09	
7.3.4	Color	-	Black	

	GLOBAL STANDARD	Page 24 of 51
	LOW VOLTAGE UNDERGROUND CABLES WITH RATED VOLTAGE $U_0/U(U_m)$ 0,6/1,0 (1,2) kV	GSC002 Rev. 05 11/2018

LOCAL SECTION A - e-distribuzione (Italy) and e-distributie (Romania)

ITEM	TITLE	DESCRIPTION														
3.3	Local StandardsLocal Standards	<p><u>e-distribuzione (Italy), e-distributie (Romania)</u></p> <ul style="list-style-type: none"> Standard PVR 006 Operational Note Vendor Rating Control: BARCODES Warranty and Traceability of Enel Distribution Materials. GUI 102/GUI 102 RO “Bobine per il trasporto di cavi elettrici, cavi ottici e conduttori per le linee elettriche di media e bassa tensione” 														
5.5	Ampacity and short-circuit rating	<p><u>e-distribuzione (Italy), e-distributie (Romania)</u></p> <p>Ampacity The ampacity estimated values shall be given for network design purposes. Such currents shall be calculated in steady state condition, for single core laying and four-core visible helix laying, when installed in open air, directly buried and buried in duct using the following operational conditions:</p> <ul style="list-style-type: none"> Maximum conductor temperature 90 °C Ambient air temperature 40 °C Ground temperature 20 °C Depth of laying 0,8 m Soil thermal resistivity 1,5 K m/W <p>Short-circuit rating The following estimated values could be used as reference</p> <table border="1" style="width: 100%; border-collapse: collapse;"> <thead> <tr> <th style="text-align: center;">Cross-section [mm²]</th> <th style="text-align: center;">Short circuit rating [kA]</th> </tr> </thead> <tbody> <tr><td style="text-align: center;">10</td><td style="text-align: center;">0,95</td></tr> <tr><td style="text-align: center;">25</td><td style="text-align: center;">2,3</td></tr> <tr><td style="text-align: center;">50</td><td style="text-align: center;">4,7</td></tr> <tr><td style="text-align: center;">95</td><td style="text-align: center;">8,9</td></tr> <tr><td style="text-align: center;">150</td><td style="text-align: center;">14,1</td></tr> <tr><td style="text-align: center;">240</td><td style="text-align: center;">22,7</td></tr> </tbody> </table> <p>The short circuit capacities are determined using the following parameters: Conductor initial temperature: 90 °C Conductor final temperature: 250 °C Short-circuit duration: 1 s</p>	Cross-section [mm ²]	Short circuit rating [kA]	10	0,95	25	2,3	50	4,7	95	8,9	150	14,1	240	22,7
Cross-section [mm ²]	Short circuit rating [kA]															
10	0,95															
25	2,3															
50	4,7															
95	8,9															
150	14,1															
240	22,7															

	GLOBAL STANDARD	Page 25 of 51
	LOW VOLTAGE UNDERGROUND CABLES WITH RATED VOLTAGE $U_0/U(U_m)$ 0,6/1,0 (1,2) kV	GSC002 Rev. 05 11/2018

LOCAL SECTION A - e-distribuzione (Italy) and e-distributie (Romania)

ITEM	TITLE	DESCRIPTION
5.6.1	Cable designation	<p><u>e-distribuzione (Italy), e-distributie (Romania)</u> The cable designation shall be the following:</p> <ul style="list-style-type: none"> • Aluminum conductor: A • Stranded compacted circular conductors: R • Cross-linked polyethylene insulation: E4 • Polyolefin sheath: E • Bundled assemble cores (if Type II): X • Assigned voltage of the cable expressed in kV: U_0/U • Nominal cross-section of the conductor <p>Example: ARE4EX-0,6/1 kV 95</p>
5.6.2	Marking	<p><u>e-distribuzione (Italy), e-distributie (Romania)</u> The marking must be indelible, easily legible and carried out by engraving or in relief on the sheath. The distance between the end of the mark and the beginning of the next identical mark does not exceed 550 mm.</p> <p>The cable marking shall contain:</p> <ul style="list-style-type: none"> • Property name: e-distribuzione or e-distributie Banat, e-distributie Dobrogea, e-distributie Muntenia • Cable designation: see 5.6.2 • Reaction to fire class (Eca) • Manufacturer name or trademark: XXXXX • Identification of the production plant with a different letter of the alphabet: B • Project index: to choose exponentially (00, 01, 02, 03). This index must be modified with every construction variation of the single core (phase or neutral). • Year and month of manufacturing (2017 12): It could be marked over a different generatrix (position) in relation to the other parameters as long as the maximum step of 1 meter is respected. In such case ink stamping could be used. • Metric marking It is put only on the core sheath of "PHASE 1" in the multipolar cables with visible helix. The inscription can be put on a cable surface other than that of the other inscriptions and it can also be made with ink. • Core identification (FASE X) for Type II: to be placed on the sheath of each core. It shall be repeated at least every 100 mm in the intervals between two subsequent series of inscriptions. The inscription shall be repeated with a step no greater than 100mm on a cable surface other than that of the inscriptions. Core identification could be made with ink.

	GLOBAL STANDARD	Page 26 of 51
	LOW VOLTAGE UNDERGROUND CABLES WITH RATED VOLTAGE $U_0/U(U_m)$ 0,6/1,0 (1,2) kV	GSC002 Rev. 05 11/2018

LOCAL SECTION A - e-distribuzione (Italy) and e-distributie (Romania)

ITEM	TITLE	DESCRIPTION
5.6.2	Marking	<p>e-distribuzione (Italy), e-distributie (Romania) <u>Marking examples</u></p> <p>a) Type I cables (1x95 mm²)</p> <p>e-distribuzione ARE4E-0,6/1 kV 50 Eca XXXX B 01 2017 12 0000 e-distributie ARE4E-0,6/1 kV 50 Eca XXXX B 01 2017 12 0000</p> <p>b) Type II cables (3x95+50N) Phase 1 core</p> <p>e-distribuzione ARE4EX-0,6/1 kV 95 Eca XXXX B 01 2017 12 0000 FASE 1... FASE 1 e-distributie ARE4EX-0,6/1 kV 95 Eca XXXX B 01 2017 12 0000 FASE 1... FASE 1</p> <p>Phase 2 or 3 core</p> <p>e-distribuzione ARE4EX-0,6/1 kV 95 Eca XXXX B 01 2017 12 FASE X FASE X e-distributie ARE4EX-0,6/1 kV 95 Eca XXXX B 01 2017 12 FASE X FASE X</p> <p>Neutral core e-distribuzione ARE4EX-0,6/1 kV 50 Eca XXXX B 01 2017 12 e-distributie ARE4EX-0,6/1 kV 50 Eca XXXX B 01 2017 12</p>







LOCAL SECTION A - e-distribuzione (Italy) and e-distributie (Romania)

ITEM	TITLE	DESCRIPTION																														
8	CONDITIONS OF SUPPLY	<p><u>e-distribuzione (Italy), e-distributie (Romania)</u></p> <p>The maximum length and reel type for each configuration of cable are depicted in the following table:</p> <table border="1" data-bbox="566 629 1098 1243"> <thead> <tr> <th data-bbox="566 629 740 757">Formation [n° x mm²]</th> <th data-bbox="740 629 911 757">Maximum Length [m]</th> <th data-bbox="911 629 1098 757">Coil Type (GUI 102)</th> </tr> </thead> <tbody> <tr> <td data-bbox="566 757 740 808">1x10</td> <td data-bbox="740 757 911 808">1000</td> <td data-bbox="911 757 1098 808">06</td> </tr> <tr> <td data-bbox="566 808 740 860">1x25</td> <td data-bbox="740 808 911 860">1000</td> <td data-bbox="911 808 1098 860">08</td> </tr> <tr> <td data-bbox="566 860 740 911">1x50</td> <td data-bbox="740 860 911 911">1000</td> <td data-bbox="911 860 1098 911">08</td> </tr> <tr> <td data-bbox="566 911 740 963">1x95</td> <td data-bbox="740 911 911 963">500</td> <td data-bbox="911 911 1098 963">10</td> </tr> <tr> <td data-bbox="566 963 740 1014">1x150</td> <td data-bbox="740 963 911 1014">500</td> <td data-bbox="911 963 1098 1014">12</td> </tr> <tr> <td data-bbox="566 1014 740 1066">1x240</td> <td data-bbox="740 1014 911 1066">500</td> <td data-bbox="911 1014 1098 1066">12</td> </tr> <tr> <td data-bbox="566 1066 740 1117">3x95+50N</td> <td data-bbox="740 1066 911 1117">500</td> <td data-bbox="911 1066 1098 1117">18</td> </tr> <tr> <td data-bbox="566 1117 740 1169">3x150+95N</td> <td data-bbox="740 1117 911 1169">500</td> <td data-bbox="911 1117 1098 1169">20</td> </tr> <tr> <td data-bbox="566 1169 740 1243">3x240+150N</td> <td data-bbox="740 1169 911 1243">500</td> <td data-bbox="911 1169 1098 1243">22</td> </tr> </tbody> </table> <p>The admitted tolerance is equal to $\pm 3\%$ of the length indicated in the order.</p> <p>Coils with total length less than indicated in the table above are permitted, as long as such reels constitute up a maximum to 10% of the cables forming the deliver batch (same transport document).</p> <p>However, each coil shall contain at least 100 m, excluding the sample sizes whose length was reduced during the acceptance test.</p> <p>The far end of the cables shall be protected against the moisture.</p> <p>Due to traceability in the network a bar code shall be applied on the drum.</p> <p>The far end of the cables shall be protected against the moisture.</p> <p>Due to traceability in the network a bar code shall be applied on the drum.</p> <p>Such bar code shall be in compliance with technical specification PVR006.</p> <p>Reels shall be made in compliance with the standard GUI102/GUI 102 RO.</p>	Formation [n° x mm ²]	Maximum Length [m]	Coil Type (GUI 102)	1x10	1000	06	1x25	1000	08	1x50	1000	08	1x95	500	10	1x150	500	12	1x240	500	12	3x95+50N	500	18	3x150+95N	500	20	3x240+150N	500	22
Formation [n° x mm ²]	Maximum Length [m]	Coil Type (GUI 102)																														
1x10	1000	06																														
1x25	1000	08																														
1x50	1000	08																														
1x95	500	10																														
1x150	500	12																														
1x240	500	12																														
3x95+50N	500	18																														
3x150+95N	500	20																														
3x240+150N	500	22																														

	GLOBAL STANDARD	Page 28 of 51
	LOW VOLTAGE UNDERGROUND CABLES WITH RATED VOLTAGE $U_0/U(U_m)$ 0,6/1,0 (1,2) kV	GSC002 Rev. 05 11/2018

LOCAL SECTION A - e-distribuzione (Italy) and e-distributie (Romania)

ITEM	TITLE	DESCRIPTION																		
8	CONDITIONS OF SUPPLY	<p>Following standard EN 50575, the CE marking and labelling shall be in accordance with the general principles set out in Article 30 of regulation (EC) No. 765/2008 and shall be affixed visibly, legibly and indelibly to the product labels affixed to the reels, coils or drums.</p> <p>The CE markings shall be followed by:</p> <ul style="list-style-type: none"> • The last two digits of the year in which it was first affixed • The name and the registered address of the manufacturer, or the identifying mark allowing identification of the name and address of the manufacturer easily and without ambiguity. • The unique identification code of the product-type • The reference number of the declaration of performance • The class of the performance declared • The date reference to the harmonized technical specification applied • The identification number of the notified body • The intended use as laid down in the applied harmonized technical specification. <p>CE marking example for products subject to AVCP system 3.</p> <table border="1" style="width: 100%; border-collapse: collapse;"> <tr> <td style="text-align: center; padding: 5px;">  XXXX </td> <td style="padding: 5px;"><i>CE marking, consisting of the "CE"-symbol</i></td> </tr> <tr> <td style="text-align: center; padding: 5px;">AnyCo Ltd, PO Box 21, B-1050, Brussels, Belgium</td> <td style="padding: 5px;"><i>Name and the registered address of the manufacturer, or identifying mark</i></td> </tr> <tr> <td style="text-align: center; padding: 5px;">14</td> <td style="padding: 5px;"><i>Last two digits of the year in which the marking was first affixed</i></td> </tr> <tr> <td style="text-align: center; padding: 5px;">(To be given by the manufacturer)</td> <td style="padding: 5px;"><i>Reference number of the DoP</i></td> </tr> <tr> <td style="text-align: center; padding: 5px;">EN 50575:2014</td> <td style="padding: 5px;"><i>No. of European Standard applied, as referenced in OJEU</i></td> </tr> <tr> <td style="text-align: center; padding: 5px;">(To be given by the manufacturer)</td> <td style="padding: 5px;"><i>Unique identification code of the product-type</i></td> </tr> <tr> <td style="text-align: center; padding: 5px;">Supply of electricity in buildings and other civil engineering works with the objective of limiting the generation and spread of fire and smoke</td> <td style="padding: 5px;"><i>Intended use of the product as laid down in the European Standard applied</i></td> </tr> <tr> <td style="text-align: center; padding: 5px;">Reaction to Fire: E</td> <td style="padding: 5px;"><i>Class of performance</i></td> </tr> <tr> <td style="text-align: center; padding: 5px;">Dangerous substances: none</td> <td></td> </tr> </table>	 XXXX	<i>CE marking, consisting of the "CE"-symbol</i>	AnyCo Ltd, PO Box 21, B-1050, Brussels, Belgium	<i>Name and the registered address of the manufacturer, or identifying mark</i>	14	<i>Last two digits of the year in which the marking was first affixed</i>	(To be given by the manufacturer)	<i>Reference number of the DoP</i>	EN 50575:2014	<i>No. of European Standard applied, as referenced in OJEU</i>	(To be given by the manufacturer)	<i>Unique identification code of the product-type</i>	Supply of electricity in buildings and other civil engineering works with the objective of limiting the generation and spread of fire and smoke	<i>Intended use of the product as laid down in the European Standard applied</i>	Reaction to Fire: E	<i>Class of performance</i>	Dangerous substances: none	
 XXXX	<i>CE marking, consisting of the "CE"-symbol</i>																			
AnyCo Ltd, PO Box 21, B-1050, Brussels, Belgium	<i>Name and the registered address of the manufacturer, or identifying mark</i>																			
14	<i>Last two digits of the year in which the marking was first affixed</i>																			
(To be given by the manufacturer)	<i>Reference number of the DoP</i>																			
EN 50575:2014	<i>No. of European Standard applied, as referenced in OJEU</i>																			
(To be given by the manufacturer)	<i>Unique identification code of the product-type</i>																			
Supply of electricity in buildings and other civil engineering works with the objective of limiting the generation and spread of fire and smoke	<i>Intended use of the product as laid down in the European Standard applied</i>																			
Reaction to Fire: E	<i>Class of performance</i>																			
Dangerous substances: none																				

	GLOBAL STANDARD	Page 29 of 51
	LOW VOLTAGE UNDERGROUND CABLES WITH RATED VOLTAGE $U_0/U(U_m)$ 0,6/1,0 (1,2) kV	GSC002 Rev. 05 11/2018

LOCAL SECTION A - e-distribuzione (Italy) and e-distributie (Romania)

ITEM	TITLE	DESCRIPTION
8	CONDITIONS OF SUPPLY	In compliance with standard EN 50575 in particular annex V of the EU Construction Products Regulation n° 305/2011 (CPR) the supplier shall elaborate a Declaration of performance (DoP) and shall dispose a CE marking in function of the assessment and verification of constancy of performance (AVCP).

	GLOBAL STANDARD	Page 30 of 51
	LOW VOLTAGE UNDERGROUND CABLES WITH RATED VOLTAGE $U_0/U(U_m)$ 0,6/1,0 (1,2) kV	GSC002 Rev. 05 11/2018

LOCAL SECTION B - ENDESA DISTRIBUCIÓN ELÉCTRICA (Spain)

ITEM	TITLE	DESCRIPTION
3.3	Local standards	<p><u>Endesa Distribución Eléctrica (Spain)</u></p> <p>c) UNE-HD 603-5X: 2007/1M "Distribution cables of rated voltage 0,6/1 kV. Par 5: XLPE insulated cables - Unarmored. Section X: Cables without concentric conductor and polyolefine compound sheath (types 5X-1 and 5X-2)</p> <p>d) UNE 211435 "Guía para la elección de cables eléctricos de tensión asignada superior o igual a 0,6/1 kV para circuitos de distribución"</p> <p>e) UNE 211605 "Ensayo de envejecimiento climático de materiales de revestimiento de cables "</p> <p>f) UNE 21167 "Bobinas de madera para cables aislados de transporte y distribución. Características generales"</p>
3.4	Replaced local standards	<p><u>Endesa Distribución Eléctrica (Spain)</u></p> <ul style="list-style-type: none"> • NCDC4147 - Cables BT para Redes Subterráneas
5.2	Insulation	The depicted material in this document can comply DIX 3 from standard HD 603 S1
5.3	Outer Sheath.	The depicted material herein can comply DMO1 from standard HD 603 S1
5.5	Ampacity and Short-circuit rating	<p><u>Endesa Distribución Eléctrica (Spain)</u></p> <p>For all uses of cables, the maximum current-carrying permitted for conductors must be in accordance with Low-Voltage Electrotechnical Regulations (REBT), approved by R.D. 842/2002, of 2 August and Standard UNE211425.</p> <p>The ampacity estimated values shall be given for network design purposes. Such currents shall be calculated in steady state condition, for a three-phase circuit (3 phases + neutral) far from any heat source using the following conditions:</p> <ul style="list-style-type: none"> • Maximum conductor temperature 90 °C • Ambient air temperature 40 °C • Ground temperature 25 °C • Depth of laying 0,7 m • Soil thermal resistivity 1,5 K m/W <p>For short-circuit rating the following condition shall be used:</p> <ul style="list-style-type: none"> • Initial conductor temperature 90 °C • Final conductor temperature 250 °C

	GLOBAL STANDARD	Page 31 of 51
	LOW VOLTAGE UNDERGROUND CABLES WITH RATED VOLTAGE $U_0/U(U_m)$ 0,6/1,0 (1,2) kV	GSC002 Rev. 05 11/2018

LOCAL SECTION B - ENDESA DISTRIBUCIÓN ELÉCTRICA (Spain)

ITEM	TITLE	DESCRIPTION
5.6.1	Cable designation	<p><u>Endesa Distribución Eléctrica (Spain)</u></p> <p>The cable designation must content:</p> <p>Structural cable characteristics</p> <p>Insulation: X (cross-linked polyethylene)</p> <p>Sheath: Z1 (polyolefin)</p> <p>Type 5X.1 S</p> <p>Assigned voltage of the cable expressed in kV: values U₀ and U: 0,6/1 kV</p> <p>Information regarding the conductor: The digit 1, corresponding to only one conductor, followed by the x sign, the nominal cross-section of the conductor expressed in sq. mm and the letter Al that indicates conductor in aluminum is used.</p> <p>Example of cable designation for Endesa:</p> <p>XZ1 (S) 0.6/1 kV 1x150 Al</p> <p>0,6/1 kV unipolar cable with 150 mm² stranded compacted aluminum conductor, insulated with cross-linked polyethylene and outer sheath made of polyolefin</p>
5.6.2	Marking	<p><u>Endesa Distribución Eléctrica (Spain)</u></p> <p>The cable marking must content:</p> <ul style="list-style-type: none"> • Name of the manufacturer • Complete cable designation • Reaction to fire class according to UNE 50575 • Last two digits of the year of production • Marking each meter • Additional markings such as traceability codes, certifies, etc. <p>The separation between the markings must not be greater than 300 mm</p> <p>Example of cable marking manufactured in 2017:</p> <p>(Name of the supplier) XZ1 (S) 0,6/1 KV 1x150 AL Eca 17 (Additional markings)</p>
6.3	Tests list for Type I and Type II cables	<p><u>PO UV RAY RESISTANCE TEST condition shall be the following:</u></p> <ul style="list-style-type: none"> • Samples: Of the outer sheath • Radiation: 43 W/m² • Nº of cycles: 1 • Chamber temperatura between phase 3 and 4 of the cycle: 55 °C • Black body máximo temperature: 70°C.

	GLOBAL STANDARD	Page 32 of 51
	LOW VOLTAGE UNDERGROUND CABLES WITH RATED VOLTAGE $U_0/U(U_m)$ 0,6/1,0 (1,2) kV	GSC002 Rev. 05 11/2018

LOCAL SECTION B - ENDESA DISTRIBUCIÓN ELÉCTRICA (Spain)

ITEM	TITLE	DESCRIPTION								
8	CONDITIONS OF SUPPLY	<p>The admitted tolerance for a samples is equal to $\pm 3\%$ of the length indicated in the order; shorter lengths are admitted up to a maximum of 10% of the cables forming the delivery lot (same transport document), provided that each one is at least 100 m; in calculating the aforesaid 10%, the sample sizes whose length is reduced due to the acceptance tests are excluded.</p> <p>Reels shall be in compliance with the Standard UNE 21167 "Bobinas de Madera para cables aislados de transporte y distribucion"</p> <p style="padding-left: 40px;">1) Technical report (TR)</p> <p>The technical report (TR) must consist of the documents described below.</p> <p>It is specified that some requirements in the following paragraphs are preceded by the word "Prescription", and others by the word "Indication".</p> <p>In the first case the requirements are normative, therefore satisfying them is a necessary (but not sufficient) condition for acceptance during the trial period. In the second case, however, the content of the required information is not binding for acceptance during the trial period.</p> <p style="padding-left: 40px;">2) Technical document.</p> <p>Technical working drawing of the coil, including representation of the two sections (longitudinal and transversal) completed with all the dimensional measurements and with the points where the drum is anchored to the flanges highlighted (enlarged diagram of the part).</p> <p>The following dimensional characteristics must be provided:</p> <p>Parts in wood:</p> <table border="1" style="margin-left: 40px;"> <tbody> <tr> <td style="padding: 5px;">For the flange</td> <td style="padding: 5px;">Board width Diameter Thickness Diameter of axial hole Counter-flange thickness</td> </tr> <tr> <td style="padding: 5px;">Coil width</td> <td style="padding: 5px;"></td> </tr> <tr> <td style="padding: 5px;">For the Drum</td> <td style="padding: 5px;">Board width diameter width Staves thickness</td> </tr> <tr> <td style="padding: 5px;">For the tie rods</td> <td style="padding: 5px;">Number diameter Length</td> </tr> </tbody> </table> <p>Metal parts</p> <p>Dimensional and number of metal components (tie rods, support and fixing plates)</p>	For the flange	Board width Diameter Thickness Diameter of axial hole Counter-flange thickness	Coil width		For the Drum	Board width diameter width Staves thickness	For the tie rods	Number diameter Length
For the flange	Board width Diameter Thickness Diameter of axial hole Counter-flange thickness									
Coil width										
For the Drum	Board width diameter width Staves thickness									
For the tie rods	Number diameter Length									

	GLOBAL STANDARD	Page 33 of 51
	LOW VOLTAGE UNDERGROUND CABLES WITH RATED VOLTAGE $U_0/U(U_m)$ 0,6/1,0 (1,2) kV	GSC002 Rev. 05 11/2018

LOCAL SECTION B - ENDESA DISTRIBUCIÓN ELÉCTRICA (Spain)

ITEM	TITLE	DESCRIPTION
8	CONDITIONS OF SUPPLY	<p>3) Photographic documentation. The following documentation shall be delivered:</p> <ul style="list-style-type: none"> • A side view and a front view photo (for a total of at least 6 photos) showing: <ul style="list-style-type: none"> -The empty coil; -The coil with wound cable without external cover; -The coil complete with external cover • The detailed view of the identification plate where the coil and supply data are provided (at an enlargement level such as to allow the information photographed to be read). <p>4) Technical data sheet of the wood. Prescriptions: Wood species coming from conifers or other wood of documented equivalent performance characteristics must be used. The wood used must be free of fungi and insects; the boards must be without non-adherent (dead) chamfers and knobs Instructions: The percentage of maximum humidity of the wood at the end of the coil fabrication process shall be stated. The description of any treatments that the wood undergoes shall be provided.</p> <p>5) Technical data sheet of the metals. Instructions: The type of material used shall be stated.</p> <p>6) Construction methods. Prescriptions: The coil must not, in any case, have metallic projections of any kind (they could in fact cause cuts or injuries during handling). Any wooden parts must not be painted. The outer surface of the drum and that inside the flange must be planed and the boards forming the flanges must be put close to each other; the nailing of the boards for the flanges must be riveted on the outside and the nail head must penetrate inside the boards by riveting.</p>

	GLOBAL STANDARD	Page 34 of 51
	LOW VOLTAGE UNDERGROUND CABLES WITH RATED VOLTAGE $U_0/U(U_m)$ 0,6/1,0 (1,2) kV	GSC002 Rev. 05 11/2018

LOCAL SECTION B - ENDESA DISTRIBUCIÓN ELÉCTRICA (Spain)

ITEM	TITLE	DESCRIPTION
8	CONDITIONS OF SUPPLY	<p>The boards of the drum must have chamfered edges and be put close to each other; uneven boards or steps between two boards or between boards and metal tie rods are not allowed.</p> <p>Instructions: Specify the welding type/technique (if present) and the anti-oxidation treatments.</p> <p>7) Protections</p> <p>The cables must be protected in such a way as to prevent damage or tampering during transport and handling, also within the sphere of ENDESA.</p> <p>If the bidder plans to use a type of protection as an alternative to staves, it must not be made with materials that during disposal are classifiable as hazardous waste; in any case, all protections that are alternatives to staves must be explicitly approved by ENDESA during homologation or during the tender process.</p> <p>The free ends of the cable must be properly protected against the penetration of water and moisture during transport, storage (which may also be outdoors) and lying.</p> <p>The finished and inspected cable coils at the Constructor's facilities cannot be parked without staves or equivalent protections in zones exposed to bad weather (sun, rain, etc.) and to accidental impacts unless for the time necessary for their staving or similar protection.</p> <p>Unless otherwise provided in the purchase order letter, the protection (staving or other) of the coils must be executed 100%.</p> <p>The spacing between the external layer of the cable and the staving must be sufficient for preventing damage to the cable and in any case never less than 50 mm; to comply with said prescription, sizes of length reduced up to the minimum allowed can be preferred, if necessary.</p> <p>8) Labeling.</p> <p>At least the following data shall be shown in addition to what is required in the order on the external surface of at least one of the flanges of the transport coil, or on the packaging of every single skein, with clearly legible and indelible characters, if applicable:</p> <ul style="list-style-type: none"> • The ENDESA code of the cable; • The name or trademark of the company that owns the coil; • The name of the Constructor of the cable; • The code and formation of the cable; • The type and code of the coil;



	GLOBAL STANDARD	Page 35 of 51
	LOW VOLTAGE UNDERGROUND CABLES WITH RATED VOLTAGE $U_0/U(U_m)$ 0,6/1,0 (1,2) kV	GSC002 Rev. 05 11/2018

LOCAL SECTION B - ENDESA DISTRIBUCIÓN ELÉCTRICA (Spain)

ITEM	TITLE	DESCRIPTION
8	CONDITIONS OF SUPPLY	<ul style="list-style-type: none"> • The total gross weight (only for the sizes on coil) • The net weight; • The weight of one meter of cable; • The actual length of the size; • The details of the ENDESA order; • The number and date of notice of shipment or, for the skeins, the number of the production lot (job no.). <p>Note: The two external faces of the flanges for coils made of wood and the two opposing faces of the pallets, which can be used for shipping several types of cable, must bear the mark demonstrating that the wood used for their construction has been treated as required in directive 2000/29/EC, referred to in SECTION 8.2.7.2.</p> <p>Following standard EN 50575, the CE marking and labelling shall be in accordance with the general principles set out in Article 30 of regulation (EC) No. 765/2008 and shall be affixed visibly, legibly and indelibly to the product labels affixed to the reels, coils or drums.</p> <p>The CE markings shall be followed by:</p> <ul style="list-style-type: none"> • The last two digits of the year in which it was first affixed • The name and the registered address of the manufacturer, or the identifying mark allowing identification of the name and address of the manufacturer easily and without ambiguity. • The unique identification code of the product-type • The reference number of the declaration of performance • The class of the performance declared • The date reference to the harmonized technical specification applied • The identification number of the notified body • The intended use as laid down in the applied harmonized technical specification. <p>CE marking example for products subject to AVCP system 3.</p>

	GLOBAL STANDARD	Page 36 of 51
	LOW VOLTAGE UNDERGROUND CABLES WITH RATED VOLTAGE $U_0/U(U_m)$ 0,6/1,0 (1,2) kV	GSC002 Rev. 05 11/2018

LOCAL SECTION B - ENDESA DISTRIBUCIÓN ELÉCTRICA (Spain)

ITEM	TITLE	DESCRIPTION														
8	CONDITIONS OF SUPPLY	<table border="1" style="width: 100%; border-collapse: collapse;"> <tr> <td style="text-align: center; padding: 10px;">  XXXX </td> <td style="padding: 10px;"><i>Marcado CE, consistente en el símbolo "CE"</i></td> </tr> <tr> <td style="text-align: center; padding: 10px;">AnyCo Ltd, PO Box 21, B-1050, Brussels, Belgium</td> <td style="padding: 10px;"><i>Número de identificación del laboratorio notificado de ensayos</i></td> </tr> <tr> <td style="text-align: center; padding: 10px;">14 (A indicar por el fabricante)</td> <td style="padding: 10px;"><i>Nombre y dirección registrada del fabricante, o marca identificativa</i></td> </tr> <tr> <td style="text-align: center; padding: 10px;">EN 50575:2014 (A indicar por el fabricante)</td> <td style="padding: 10px;"><i>Los dos últimos dígitos del año en que se fijó el marcado por primera vez</i></td> </tr> <tr> <td style="text-align: center; padding: 10px;">Suministro de electricidad en edificios y en otras obras de ingeniería civil con el objetivo de limitar la generación y propagación de fuego y humo</td> <td style="padding: 10px;"><i>Número de referencia de la Declaración de Prestaciones (DoP)</i></td> </tr> <tr> <td style="text-align: center; padding: 10px;">Reacción al fuego: E_{ca}</td> <td style="padding: 10px;"><i>Código de la norma europea de aplicación, como se cite en el DOUE</i></td> </tr> <tr> <td style="text-align: center; padding: 10px;">Sustancias peligrosas: Ninguna</td> <td style="padding: 10px;"><i>Código de identificación único del producto tipo</i></td> </tr> </table> <p>9) Transport</p> <p>In order to facilitate unloading, drums should be arranged in the vehicle with a distance between the covers for inputting the charging and discharging means, so that either can be discharged with handling means with forks.</p> <p>In compliance with standard EN 50575 in particular annex V of the EU Construction Products Regulation n° 305/2011 (CPR) the supplier shall elaborate a Declaration of performance (DoP) and shall dispose a CE marking in function of the assessment and verification of constancy of performance (AVCP).</p>	 XXXX	<i>Marcado CE, consistente en el símbolo "CE"</i>	AnyCo Ltd, PO Box 21, B-1050, Brussels, Belgium	<i>Número de identificación del laboratorio notificado de ensayos</i>	14 (A indicar por el fabricante)	<i>Nombre y dirección registrada del fabricante, o marca identificativa</i>	EN 50575:2014 (A indicar por el fabricante)	<i>Los dos últimos dígitos del año en que se fijó el marcado por primera vez</i>	Suministro de electricidad en edificios y en otras obras de ingeniería civil con el objetivo de limitar la generación y propagación de fuego y humo	<i>Número de referencia de la Declaración de Prestaciones (DoP)</i>	Reacción al fuego: E _{ca}	<i>Código de la norma europea de aplicación, como se cite en el DOUE</i>	Sustancias peligrosas: Ninguna	<i>Código de identificación único del producto tipo</i>
 XXXX	<i>Marcado CE, consistente en el símbolo "CE"</i>															
AnyCo Ltd, PO Box 21, B-1050, Brussels, Belgium	<i>Número de identificación del laboratorio notificado de ensayos</i>															
14 (A indicar por el fabricante)	<i>Nombre y dirección registrada del fabricante, o marca identificativa</i>															
EN 50575:2014 (A indicar por el fabricante)	<i>Los dos últimos dígitos del año en que se fijó el marcado por primera vez</i>															
Suministro de electricidad en edificios y en otras obras de ingeniería civil con el objetivo de limitar la generación y propagación de fuego y humo	<i>Número de referencia de la Declaración de Prestaciones (DoP)</i>															
Reacción al fuego: E _{ca}	<i>Código de la norma europea de aplicación, como se cite en el DOUE</i>															
Sustancias peligrosas: Ninguna	<i>Código de identificación único del producto tipo</i>															

	GLOBAL STANDARD	Page 37 of 51
	LOW VOLTAGE UNDERGROUND CABLES WITH RATED VOLTAGE $U_0/U(U_m)$ 0,6/1,0 (1,2) kV	GSC002 Rev. 05 11/2018

LOCAL SECTION C- LATAM

ITEM	TITLE	DESCRIPTION														
3.4	Replaced Local Standards Local Standards	<u>Argentina, Brazil, Chile, Colombia and Peru</u> E-BT-001 Especificación Técnica: Cables unipolares Aislados de Baja Tensión.														
5.5	Ampacity and Short-circuit rating	<p><u>Brazil, Chile, Colombia and Peru</u></p> <p>The ampacity estimated values shall be given for network design purposes. Such currents shall be calculated in steady state condition, for single core laying and four-core visible helix laying, when installed in open air, directly buried and buried in duct using the following operational conditions:</p> <ul style="list-style-type: none"> • Maximum conductor temperature 90 °C • Ambient air temperature 40 °C • Ground temperature 20 °C • Depth of laying 0,8 m • Soil thermal resistivity 1,5 K m/W <p><u>For Perú</u></p> <p>Ampacity</p> <p>The ampacity estimated values shall be given for network design purposes. Such currents shall be calculated according to “CNE suministro 2011” using the following conditions:</p> <ul style="list-style-type: none"> • Maximum conductor temperature 90 °C • Ambient air temperature 30 °C • Ground temperature 25 °C • Depth of laying 0,6 m <p>Soil thermal resistivity 1,5 K m/W</p> <p>Short-circuit rating</p> <p>The following estimated values could be used as reference for aluminum cables</p> <table border="1" style="width: 100%; border-collapse: collapse;"> <thead> <tr> <th style="text-align: center;">Cross-section [mm²]</th> <th style="text-align: center;">Short circuit rating [kA]</th> </tr> </thead> <tbody> <tr><td style="text-align: center;">16</td><td style="text-align: center;">1,50</td></tr> <tr><td style="text-align: center;">25</td><td style="text-align: center;">2,40</td></tr> <tr><td style="text-align: center;">50</td><td style="text-align: center;">4,70</td></tr> <tr><td style="text-align: center;">95</td><td style="text-align: center;">8,90</td></tr> <tr><td style="text-align: center;">150</td><td style="text-align: center;">14,30</td></tr> <tr><td style="text-align: center;">240</td><td style="text-align: center;">22,80</td></tr> </tbody> </table> <p>The short circuit capacities are determined using the following parameters:</p> <p>Conductor initial temperature: 90 °C Conductor final temperature: 250 °C Short-circuit duration: 1 s</p>	Cross-section [mm ²]	Short circuit rating [kA]	16	1,50	25	2,40	50	4,70	95	8,90	150	14,30	240	22,80
Cross-section [mm ²]	Short circuit rating [kA]															
16	1,50															
25	2,40															
50	4,70															
95	8,90															
150	14,30															
240	22,80															

	GLOBAL STANDARD	Page 38 of 51
	LOW VOLTAGE UNDERGROUND CABLES WITH RATED VOLTAGE $U_0/U(U_m)$ 0,6/1,0 (1,2) kV	GSC002 Rev. 05 11/2018

LOCAL SECTION C- LATAM

ITEM	TITLE	DESCRIPTION
5.5	Ampacity and Short-circuit rating	<p><u>Argentina</u> The ampacity estimated values shall be given for network design purposes. Such currents shall be calculated according to AEA 95101 using the following conditions:</p> <ul style="list-style-type: none"> • Maximum conductor temperature 90 °C • Ambient air temperature 30 °C • Ground temperature 20 °C • Depth of laying 0,7 m <p>Soil thermal resistivity 1,5 K m/W</p>
5.6.1	Cable designation	<p><u>Argentina, Brazil, Chile, Colombia</u></p> <ul style="list-style-type: none"> • Conductor: <ul style="list-style-type: none"> 1) NA2XY: Stranded compacted circular (class 2) aluminum conductor • Insulation: <ul style="list-style-type: none"> XR: cross-linked polyethylene • Outer sheath: <ul style="list-style-type: none"> PO: Polyolefin • Nominal cross-sectional area: XXX mm² • Rated voltage: 0,6/1(1,2) kV <p><u>Example:</u> NA2XY-XR-PO 240mm² 0,6/1 (1,2) kV</p> <p>150 mm² Stranded compacted aluminum conductor (class 2), cross-linked polyethylene insulation, polyolefin outer sheath with rated voltage 0.6/1 kV</p>
5.6.1	Cable designation	<p><u>Peru</u></p> <ul style="list-style-type: none"> • Aluminum conductor: AL • Cross-linked polyethylene insulation: XLPE • Polyolefin outer sheath: PO • Rated voltage: 0,6/1(1,2) kV • Nominal cross-sectional area: XXX mm² <p><u>Example:</u> AL-XLPE-PO 0,6/1 (1,2) kV 1x150 mm²</p> <p>150 mm² Stranded compacted aluminum conductor, cross-linked polyethylene insulation, polyolefin outer sheath for nominal voltage 0.6/1 kV</p>

	GLOBAL STANDARD	Page 39 of 51
	LOW VOLTAGE UNDERGROUND CABLES WITH RATED VOLTAGE $U_0/U(U_m)$ 0,6/1,0 (1,2) kV	GSC002 Rev. 05 11/2018

LOCAL SECTION C- LATAM

ITEM	TITLE	DESCRIPTION
5.6.2	Marking	<p><u>Argentina, Brazil, Chile, Colombia and Peru</u></p> <p>The cable shall be marked on the outer sheath for each meter in length,</p> <ul style="list-style-type: none"> • Name of Distribution Company (XXXX) (BOG-CUN for Codensa) • Name of the Manufacturer (NNN) • Cable designation (see 5.6.1) • Manufactured year and month (MM/YYYY) • Footage correlative / marking sequence (mm) • Maximum operating temperature (only for Condensa according RETIE) • The separation between the markings must not be greater than 550cm markings with paint shall pass the adherence test, the markings must be perfectly legible. <p>Examples:</p> <p>XXXX NNN NA2XY-XR-PO 240mm² 0,6/1 (1,2)kV 09/2017 mm</p> <p>XXXX NNN AL-XLPE-PO 0,6/1 (1,2) kV 1x150 mm² 09/2017 mm</p>
8	CONDITIONS OF SUPPLY	<p><u>Argentina, Brazil, Chile, Colombia and Peru</u></p> <p>PACKAGING AND LABELING</p> <p>The conductor will be delivered by the manufacturer in wood or metal drum, which will not be returned, according to maximum and minimum dimensions shown in Table A and according to Figure N° 3.</p> <p>The total length of the driver given on each reel may not be less than requested in the purchase order and shall not exceed by more than ±5%. The maximum gross weight of the reel is packed 2,200 kg.</p> <p>It should protect the ends of each cable reel with caps to prevent moisture ingress and must be internally secured to the spool ends, and must be mechanically protected against possible damages from the handling and transport of each reel , leaving both accessible through the use of internal helix or conch in each reel ends. When the distance between the source of manufacture and storage location of the purchaser involving only a means of transport and less than 200 km away ,the use of internal propeller only reels of conductors greater than or equal to 120 mm² section is required ; this restriction does not release moisture protection of both visible ends of the conductor, mechanical protection and careful handling of the reels.</p>

LOCAL SECTION C LATAM

ITEM	TITLE	DESCRIPTION															
8	CONDITIONS OF SUPPLY	<p><u>Argentina, Brazil, Chile, Colombia and Peru</u></p> <p>The wooden spools will be treated according to international requirements for pest control , avoiding the compound " Pentachlorophenol " and " Creosote " . Treatment should include, at least : high toxicity to decay organisms , high penetration and holding power , chemical stability, non-corrosive to metals and substances affecting physical characteristics of the wood and weather protection</p> <p>Note: The purchase order could specify a maximum length of cable in drum.</p> <div data-bbox="571 790 1425 1261" style="text-align: center;"> </div> <p>Figure N° 3 Trial type</p> <table border="1" data-bbox="778 1339 1369 1503"> <thead> <tr> <th>A⁽¹⁾</th> <th>B</th> <th>C ⁽¹⁾</th> <th>D⁽²⁾</th> <th>E</th> </tr> <tr> <th>mm</th> <th>mm</th> <th>mm</th> <th>mm</th> <th>mm</th> </tr> </thead> <tbody> <tr> <td>1730</td> <td>(3)</td> <td>1120</td> <td>80</td> <td>(4)</td> </tr> </tbody> </table> <p>Table A Trial dimension</p> <p>Notes:</p> <p>(1) Maximum value.</p> <p>(2) Minimum value</p> <p>(3) EI Double the minimum cable curvature radius for transportation, in accordance with Manufacturer specifications.</p> <p>(4) 300 or 180 mm, in accordance with the type of spool (large or small, respectively)</p>	A ⁽¹⁾	B	C ⁽¹⁾	D ⁽²⁾	E	mm	mm	mm	mm	mm	1730	(3)	1120	80	(4)
A ⁽¹⁾	B	C ⁽¹⁾	D ⁽²⁾	E													
mm	mm	mm	mm	mm													
1730	(3)	1120	80	(4)													

	GLOBAL STANDARD	Page 41 of 51
	LOW VOLTAGE UNDERGROUND CABLES WITH RATED VOLTAGE $U_0/U(U_m)$ 0,6/1,0 (1,2) kV	GSC002 Rev. 05 11/2018

LOCAL SECTION C LATAM

ITEM	TITLE	DESCRIPTION
8	CONDITIONS OF SUPPLY	<p><u>Brazil, Chile</u></p> <p>All spools must:</p> <ol style="list-style-type: none"> 1) Be protected by wooden staves on the exterior, which are to be secured to the wooden spools. An equivalent system is to be used on the metal spools. The staves are to be fastened by steel or plastic bands. 2) Show the correct direction for unwinding the spools, by means of an arrow located on the sides. 3) Have a rustproof nameplate on each side of the spool. Each nameplate will show the following information (as a minimum), in the language of the country where the cable is to be used (Spanish or Portuguese). <p>The following data will be required:</p> <ul style="list-style-type: none"> • Name of the Manufacturer • Country of origin of the batch • The words: "ENEL GROUP" • Purchase Order number • Maximum voltage between lines • Conductor Material and insulation type • Nominal cross-sectional area (mm²) • Number of the spool within the batch • Net weight and gross weight, in kg. • Length of the conductor, in meters.
8	CONDITIONS OF SUPPLY	<p><u>Peru</u></p> <p>The following data shall be reported on the flange</p> <ol style="list-style-type: none"> 1) Enel Distribución Peru 2) Name of the manufacturer 3) Country of origin of the item 4) Country code 5) Description of item 6) Year and month of manufacture 7) Number of the spool within the delivered batch. 8) Cable length, in meters. 9) the metric initial (m) 10) the metric final (m)

	GLOBAL STANDARD	Page 42 of 51
	LOW VOLTAGE UNDERGROUND CABLES WITH RATED VOLTAGE $U_0/U(U_m)$ 0,6/1,0 (1,2) kV	GSC002 Rev. 05 11/2018

LOCAL SECTION C LATAM

ITEM	TITLE	DESCRIPTION
8	CONDITIONS OF SUPPLY	<u>Peru</u> 11) Manufacture standard 12) Purchase Order N° 13) Rated Voltage (12/20(24) kV) 14) Insulation material and type 15) Conductor caliber (mm ²) 16) Net weight and gross weight in kg. 17) Weight of the coil in kg 18) Weight of one meter of cable in kg 19) Cable type 20) Cable length, in meters. 21) Coil dimension in mm.
8	CONDITIONS OF SUPPLY	<u>Argentina</u> Reels must meet the requirements of the IRAM 9590-1 standard

COMMON LIST OF MAIN REQUIREMENTS

GS Type Code	Distribution Company and Country	Country Code	Rated Voltage U_0/U [kV]	Cross-section [mm ²]	Type of Cable	Conductor material	Minimum Number of Wires of Conductor	Minimum conductor diameter [mm]	Maximum conductor diameter [mm]	Insulation Material	Insulation nominal thickness [mm]	Insulation minimum thickness [mm]	Sheath Material	Sheath nominal thickness [mm]	Sheath minimum thickness [mm]	Sheath Colour	Assembly	Neutral conductor
GSC002/001	ED-ITALY	330300	0.6/1.0	1x10	I	ALUMINUM	6	3,6	4,2	XLPE	0,7	0,53	PO	1,3	1,01	Black	Unipolar	-
GSC002/001	ED-ROMANIA	330300	0.6/1.0	1x10	I	ALUMINUM	6	3,6	4,2	XLPE	0,7	0,53	PO	1,3	1,01	Black	Unipolar	-
GSC002/001	ED-PERU	6815705	0.6/1.0	1x10	I	ALUMINUM	6	3,6	4,2	XLPE	0,7	0,53	PO	1,3	1,01	Black	Unipolar	-
GSC002/002	RJ/CE/GO-BRAZIL	T330006	0.6/1.1	1x16	I	ALUMINUM	6	4,6	5,2	XLPE	0,7	0,53	PO	1,3	1,01	Black	Unipolar	-
GSC002/002	ED-CHILE	330279	0.6/1.0	1X16	I	ALUMINUM	6	4,6	5,2	XLPE	0,7	0,53	PO	1,3	1,01	Black	Unipolar	-
GSC002/003	ED-PERU	6815727	0.6/1.0	1X25	I	ALUMINUM	6	5,6	6,5	XLPE	0,9	0,71	PO	1,3	1,01	Black	Unipolar	-
GSC002/003	ED-ITALY	33 03 01	0.6/1.0	1X25	I	ALUMINUM	6	5,6	6,5	XLPE	0,9	0,71	PO	1,3	1,01	Black	Unipolar	-
GSC002/003	ED-ROMANIA	33 03 01	0.6/1.0	1X25	I	ALUMINUM	6	5,6	6,5	XLPE	0,9	0,71	PO	1,3	1,01	Black	Unipolar	-
GSC002/003	ED-COLOMBIA	T330015	0.6/1.0	1X25	I	AA-8000	6	5,6	6,5	XLPE	0,9	0,71	PO	1,3	1,01	Black	Unipolar	-
GSC002/003	ED-CHILE	330280	0.6/1.0	1X25	I	ALUMINUM	6	5,6	6,5	XLPE	0,9	0,71	PO	1,3	1,01	Black	Unipolar	-

	GLOBAL STANDARD	Page 44 of 51
	LOW VOLTAGE UNDERGROUND CABLES WITH RATED VOLTAGE $U_0/U(U_m)$ 0,6/1,0 (1,2) kV	GSC002 Rev. 05 11/2018

GS Type Code	Distribution Company and Country	Country Code	Rated Voltage U_0/U [kV]	Cross-section [mm ²]	Type of Cable	Conductor material	Minimum Number of Wires of Conductor	Minimum conductor diameter [mm]	Maximum conductor diameter [mm]	Insulation Material	Insulation nominal thickness [mm]	Insulation minimum thickness [mm]	Sheath Material	Sheath nominal thickness [mm]	Sheath minimum thickness [mm]	Sheath Colour	Assembly	Neutral conductor
GSC002/003	RJ/CE/GO-BRAZIL	T330066	0.6/1.0	1X25	I	ALUMINUM	6	5,6	6,5	XLPE	0,9	0,71	PO	1,3	1,01	Black	Unipolar	-
GSC002/004	ED-PERU	6815728	0.6/1.0	1x35	I	ALUMINUM	6	6,6	7,5	XLPE	0,9	0,71	PO	1,3	1,01	Black	Unipolar	-
GSC002/004	ED-COLOMBIA	T330113	0.6/1.0	1x35	I	AA-8000	6	6,6	7,5	XLPE	0,9	0,71	PO	1,3	1,01	Black	Unipolar	-
GSC002/005	EE-SPAIN	330006	0.6/1.0	1X50	I	ALUMINUM	6	7,7	8,6	XLPE	1	0,8	PO	1,3	1,01	Black	Unipolar	-
GSC002/005	ED-ITALY	330302	0.6/1.0	1X50	I	ALUMINUM	6	7,7	8,6	XLPE	1	0,8	PO	1,3	1,01	Black	Unipolar	-
GSC002/005	ED-ROMANIA	330302	0.6/1.0	1X50	I	ALUMINUM	6	7,7	8,6	XLPE	1	0,8	PO	1,3	1,01	Black	Unipolar	-
GSC002/005	RJ/CE/GO-BRAZIL	T330067	0.6/1.0	1X50	I	ALUMINUM	6	7,7	8,6	XLPE	1	0,8	PO	1,3	1,01	Black	Unipolar	-
GSC002/006	ED-PERU	6815729	0.6/1.0	1x70	I	ALUMINUM	12	9,3	10,2	XLPE	1,1	0,89	PO	1,4	1,09	Black	Unipolar	-
GSC002/006	ED-COLOMBIA	T330018	0.6/1.0	1X70	I	AA-8000	12	9,3	10,2	XLPE	1,1	0,89	PO	1,4	1,09	Black	Unipolar	-
GSC002/006	ED-CHILE	330281	0.6/1.0	1x70	I	ALUMINUM	12	9,3	10,2	XLPE	1,1	0,89	PO	1,4	1,09	Black	Unipolar	-
GSC002/006	RJ/CE/GO-BRAZIL	T330081	0.6/1.0	1x70	I	ALUMINUM	12	9,3	10,2	XLPE	1,1	0,89	PO	1,4	1,09	Black	Unipolar	-

	GLOBAL STANDARD	Page 45 of 51
	LOW VOLTAGE UNDERGROUND CABLES WITH RATED VOLTAGE $U_0/U(U_m)$ 0,6/1,0 (1,2) kV	GSC002 Rev. 05 11/2018

GS Type Code	Distribution Company and Country	Country Code	Rated Voltage U_0/U [kV]	Cross-section [mm ²]	Type of Cable	Conductor material	Minimum Number of Wires of Conductor	Minimum conductor diameter [mm]	Maximum conductor diameter [mm]	Insulation Material	Insulation nominal thickness [mm]	Insulation minimum thickness [mm]	Sheath Material	Sheath nominal thickness [mm]	Sheath minimum thickness [mm]	Sheath Colour	Assembly	Neutral conductor
GSC002/007	EE-SPAIN	330007	0.6/1.0	1X95	I	ALUMINUM	15	11	12	XLPE	1,1	0,89	PO	1,4	1,09	Black	Unipolar	-
GSC002/007	ED-ITALY	330303	0.6/1.0	1X95	I	ALUMINUM	15	11	12	XLPE	1,1	0,89	PO	1,4	1,09	Black	Unipolar	-
GSC002/007	ED-ROMANIA	330303	0.6/1.0	1X95	I	ALUMINUM	15	11	12	XLPE	1,1	0,89	PO	1,4	1,09	Black	Unipolar	-
GSC002/008	EE-SPAIN	330008	0.6/1.0	1X150	I	ALUMINUM	15	13,7	15	XLPE	1,4	1,16	PO	1,4	1,09	Black	Unipolar	-
GSC002/008	ED-PERU	6815730	0.6/1.0	1X150	I	ALUMINUM	15	13,7	15	XLPE	1,4	1,16	PO	1,4	1,09	Black	Unipolar	-
GSC002/008	ED-ITALY	330304	0.6/1.0	1X150	I	ALUMINUM	15	13,7	15	XLPE	1,4	1,16	PO	1,4	1,09	Black	Unipolar	-
GSC002/008	ED-ROMANIA	330304	0.6/1.0	1X150	I	ALUMINUM	15	13,7	15	XLPE	1,4	1,16	PO	1,4	1,09	Black	Unipolar	-
GSC002/008	ED-COLOMBIA	T330002	0.6/1.0	1X150	I	AA-8000	15	13,7	15	XLPE	1,4	1,16	PO	1,4	1,09	Black	Unipolar	-
GSC002/008	ED-CHILE	330282	0.6/1.0	1X150	I	ALUMINUM	15	13,7	15	XLPE	1,4	1,16	PO	1,4	1,09	Black	Unipolar	-
GSC002/008	RJ/CE/GO-BRAZIL	T330065	0.6/1.0	1X150	I	ALUMINUM	15	13,7	15	XLPE	1,4	1,16	PO	1,4	1,09	Black	Unipolar	-
GSC002/009	EE-SPAIN	330009	0.6/1.0	1X240	I	ALUMINUM	30	17,6	19,2	XLPE	1,7	1,43	PO	1,5	1,175	Black	Unipolar	-

	GLOBAL STANDARD	Page 46 of 51
	LOW VOLTAGE UNDERGROUND CABLES WITH RATED VOLTAGE $U_0/U(U_m)$ 0,6/1,0 (1,2) kV	GSC002 Rev. 05 11/2018

GS Type Code	Distribution Company and Country	Country Code	Rated Voltage U_0/U [kV]	Cross-section [mm ²]	Type of Cable	Conductor material	Minimum Number of Wires of Conductor	Minimum conductor diameter [mm]	Maximum conductor diameter [mm]	Insulation Material	Insulation nominal thickness [mm]	Insulation minimum thickness [mm]	Sheath Material	Sheath nominal thickness [mm]	Sheath minimum thickness [mm]	Sheath Colour	Assembly	Neutral conductor
GSC002/009	ED-PERU	6815731	0.6/1.0	1X240	I	ALUMINUM	30	17,6	19,2	XLPE	1,7	1,43	PO	1,5	1,175	Black	Unipolar	-
GSC002/009	ED-ITALY	330305	0.6/1.0	1X240	I	ALUMINUM	30	17,6	19,2	XLPE	1,7	1,43	PO	1,5	1,175	Black	Unipolar	-
GSC002/009	ED-ROMANIA	330305	0.6/1.0	1X240	I	ALUMINUM	30	17,6	19,2	XLPE	1,7	1,43	PO	1,5	1,175	Black	Unipolar	-
GSC002/009	RJ/CE/GO-BRAZIL	T330013	0.6/1.0	1X240	I	ALUMINUM	30	17,6	19,2	XLPE	1,7	1,43	PO	1,5	1,175	Black	Unipolar	-
GSC002/009	ED-COLOMBIA	T330017	0.6/1.0	1X240	I	AA-8000	30	17,6	19,2	XLPE	1,7	1,43	PO	1,5	1,175	Black	Unipolar	-
GSC002/009	ED-CHILE	330283	0.6/1.0	1X240	I	ALUMINUM	30	17,6	19,2	XLPE	1,7	1,43	PO	1,5	1,175	Black	Unipolar	-
GSC002/010	ED-ITALY	330655	0.6/1.0	3x95+50N	II	ALUMINUM	15	11	12	XLPE	1,1	0,89	PO	1,4	1,09	Black	Quadripolar	Same as GSC002/005
GSC002/010	ED-ROMANIA	330655	0.6/1.0	3x95+50N	II	ALUMINUM	15	11	12	XLPE	1,1	0,89	PO	1,4	1,09	Black	Quadripolar	Same as GSC002/005
GSC002/010	ED-ARGENTINA	0101-0487	0.6/1.1	3x95+50N	II	ALUMINUM	15	11	12	XLPE	1,1	0,89	PO	1,4	1,09	Black	Quadripolar	Same as GSC002/005
GSC002/011	ED-ITALY	330656	0.6/1.0	3x150+95N	II	ALUMINUM	15	13,7	15	XLPE	1,4	1,16	PO	1,4	1,09	Black	Quadripolar	Same as GSC002/007
GSC002/011	ED-ROMANIA	330656	0.6/1.0	3x150+95N	II	ALUMINUM	15	13,7	15	XLPE	1,4	1,16	PO	1,4	1,09	Black	Quadripolar	Same as GSC002/007

	GLOBAL STANDARD	Page 47 of 51
	LOW VOLTAGE UNDERGROUND CABLES WITH RATED VOLTAGE $U_0/U(U_m)$ 0,6/1,0 (1,2) kV	GSC002 Rev. 05 11/2018

GS Type Code	Distribution Company and Country	Country Code	Rated Voltage U_0/U [kV]	Cross-section [mm ²]	Type of Cable	Conductor material	Minimum Number of Wires of Conductor	Minimum conductor diameter [mm]	Maximum conductor diameter [mm]	Insulation Material	Insulation nominal thickness [mm]	Insulation minimum thickness [mm]	Sheath Material	Sheath nominal thickness [mm]	Sheath minimum thickness [mm]	Sheath Colour	Assembly	Neutral conductor
GSC002/012	ED-ITALY	330657	0.6/1.0	3x240+150N	II	ALUMINUM	30	17,6	19,2	XLPE	1,7	1,43	PO	1,5	1,175	Black	Quadripolar	Same as GSC002/008
GSC002/012	ED-ROMANIA	330657	0.6/1.0	3x240+150N	II	ALUMINUM	30	17,6	19,2	XLPE	1,7	1,43	PO	1,5	1,175	Black	Quadripolar	Same as GSC002/008
GSC002/012	ED-ARGENTINA	0101-0488	0.6/1.0	3x240+150N	II	ALUMINUM	30	17,6	19,2	XLPE	1,7	1,43	PO	1,5	1,175	Black	Quadripolar	Same as GSC002/008

GS Type Code	Distribution Company and Country	Country Code	TAM description
GSC002/001	ED-ITALY	330300	LV UNDERGROUND CABLE 1x10 ALUMINUM CONDUCTOR XLPE INSULATION PO JACKET
GSC002/001	ED-ROMANIA	330300	LV UNDERGROUND CABLE 1x10 ALUMINUM CONDUCTOR XLPE INSULATION PO JACKET
GSC002/001	ED-PERU	6815705	LV UNDERGROUND CABLE 1x10 ALUMINUM CONDUCTOR XLPE INSULATION PO JACKET
GSC002/002	RJ/CE/GO-BRAZIL	T330006	LV UNDERGROUND CABLE 1x16 ALUMINUM CONDUCTOR XLPE INSULATION PO JACKET
GSC002/002	ED-CHILE	330279	LV UNDERGROUND CABLE 1X16 ALUMINUM CONDUCTOR XLPE INSULATION PO JACKET
GSC002/003	ED-PERU	6815727	LV UNDERGROUND CABLE 1X25 ALUMINUM CONDUCTOR XLPE INSULATION PO JACKET
GSC002/003	ED-ITALY	33 03 01	LV UNDERGROUND CABLE 1X25 ALUMINUM CONDUCTOR XLPE INSULATION PO JACKET
GSC002/003	ED-ROMANIA	33 03 01	LV UNDERGROUND CABLE 1X25 ALUMINUM CONDUCTOR XLPE INSULATION PO JACKET
GSC002/003	ED-COLOMBIA	T330015	LV UNDERGROUND CABLE 1X25 AA-8000 CONDUCTOR XLPE INSULATION PO JACKET
GSC002/003	ED-CHILE	330280	LV UNDERGROUND CABLE 1X25 ALUMINUM CONDUCTOR XLPE INSULATION PO JACKET

GSC002/003	RJ/CE/GO-BRAZIL	T330066	LV UNDERGROUND CABLE 1X25 ALUMINUM CONDUCTOR XLPE INSULATION PO JACKET
GSC002/004	ED-PERU	6815728	LV UNDERGROUND CABLE 1x35 ALUMINUM CONDUCTOR XLPE INSULATION PO JACKET
GSC002/004	ED-COLOMBIA	T330113	LV UNDERGROUND CABLE 1x35 AA-8000 CONDUCTOR XLPE INSULATION PO JACKET
GSC002/005	EE-SPAIN	330006	LV UNDERGROUND CABLE 1X50 ALUMINUM CONDUCTOR XLPE INSULATION PO JACKET
GSC002/005	ED-ITALY	33 03 02	LV UNDERGROUND CABLE 1X50 ALUMINUM CONDUCTOR XLPE INSULATION PO JACKET
GSC002/005	ED-ROMANIA	33 03 02	LV UNDERGROUND CABLE 1X50 ALUMINUM CONDUCTOR XLPE INSULATION PO JACKET
GSC002/005	RJ/CE/GO-BRAZIL	T330067	LV UNDERGROUND CABLE 1X50 ALUMINUM CONDUCTOR XLPE INSULATION PO JACKET
GSC002/006	ED-PERU	6815729	LV UNDERGROUND CABLE 1x70 ALUMINUM CONDUCTOR XLPE INSULATION PO JACKET
GSC002/006	ED-COLOMBIA	T330018	LV UNDERGROUND CABLE 1X70 AA-8000 CONDUCTOR XLPE INSULATION PO JACKET
GSC002/006	ED-CHILE	330281	LV UNDERGROUND CABLE 1x70 ALUMINUM CONDUCTOR XLPE INSULATION PO JACKET
GSC002/006	RJ/CE/GO-BRAZIL	T330081	LV UNDERGROUND CABLE 1x70 ALUMINUM CONDUCTOR XLPE INSULATION PO JACKET
GSC002/007	EE-SPAIN	330007	LV UNDERGROUND CABLE 1X95 ALUMINUM CONDUCTOR XLPE INSULATION PO JACKET

	GLOBAL STANDARD	Page 50 of 51
	LOW VOLTAGE UNDERGROUND CABLES WITH RATED VOLTAGE $U_0/U(U_m)$ 0,6/1,0 (1,2) kV	GSC002 Rev. 05 11/2018

GSC002/007	ED-ITALY	33 03 03	LV UNDERGROUND CABLE 1X95 ALUMINUM CONDUCTOR XLPE INSULATION PO JACKET
GSC002/007	ED-ROMANIA	33 03 03	LV UNDERGROUND CABLE 1X95 ALUMINUM CONDUCTOR XLPE INSULATION PO JACKET
GSC002/008	EE-SPAIN	330008	LV UNDERGROUND CABLE 1X150 ALUMINUM CONDUCTOR XLPE INSULATION PO JACKET
GSC002/008	ED-PERU	6815730	LV UNDERGROUND CABLE 1X150 ALUMINUM CONDUCTOR XLPE INSULATION PO JACKET
GSC002/008	ED-ITALY	33 03 04	LV UNDERGROUND CABLE 1X150 ALUMINUM CONDUCTOR XLPE INSULATION PO JACKET
GSC002/008	ED-ROMANIA	33 03 04	LV UNDERGROUND CABLE 1X150 ALUMINUM CONDUCTOR XLPE INSULATION PO JACKET
GSC002/008	ED-COLOMBIA	T330002	LV UNDERGROUND CABLE 1X150 AA-8000 CONDUCTOR XLPE INSULATION PO JACKET
GSC002/008	ED-CHILE	330282	LV UNDERGROUND CABLE 1X150 ALUMINUM CONDUCTOR XLPE INSULATION PO JACKET
GSC002/008	RJ/CE/GO-BRAZIL	T330065	LV UNDERGROUND CABLE 1X150 ALUMINUM CONDUCTOR XLPE INSULATION PO JACKET
GSC002/009	EE-SPAIN	330009	LV UNDERGROUND CABLE 1X240 ALUMINUM CONDUCTOR XLPE INSULATION PO JACKET
GSC002/009	ED-PERU	6815731	LV UNDERGROUND CABLE 1X240 ALUMINUM CONDUCTOR XLPE INSULATION PO JACKET
GSC002/009	ED-ITALY	33 03 05	LV UNDERGROUND CABLE 1X240 ALUMINUM CONDUCTOR XLPE INSULATION PO JACKET

GSC002/009	ED-ROMANIA	33 03 05	LV UNDERGROUND CABLE 1X240 ALUMINUM CONDUCTOR XLPE INSULATION PO JACKET
GSC002/009	RJ/CE/GO-BRAZIL	T330013	LV UNDERGROUND CABLE 1X240 ALUMINUM CONDUCTOR XLPE INSULATION PO JACKET
GSC002/009	ED-COLOMBIA	T330017	LV UNDERGROUND CABLE 1X240 AA-8000 CONDUCTOR XLPE INSULATION PO JACKET
GSC002/009	ED-CHILE	330283	LV UNDERGROUND CABLE 1X240 ALUMINUM CONDUCTOR XLPE INSULATION PO JACKET
GSC002/010	ED-ITALY	330655	LV UNDERGROUND CABLE 3x95+50N ALUMINUM CONDUCTOR XLPE INSULATION PO JACKET
GSC002/010	ED-ROMANIA	330655	LV UNDERGROUND CABLE 3x95+50N ALUMINUM CONDUCTOR XLPE INSULATION PO JACKET
GSC002/010	ED-ARGENTINA	0101-0487	LV UNDERGROUND CABLE 3x95+50N ALUMINUM CONDUCTOR XLPE INSULATION PO JACKET
GSC002/011	ED-ITALY	330656	LV UNDERGROUND CABLE 3x150+95N ALUMINUM CONDUCTOR XLPE INSULATION PO JACKET
GSC002/011	ED-ROMANIA	330656	LV UNDERGROUND CABLE 3x150+95N ALUMINUM CONDUCTOR XLPE INSULATION PO JACKET
GSC002/012	ED-ITALY	330657	LV UNDERGROUND CABLE 3x240+150N ALUMINUM CONDUCTOR XLPE INSULATION PO JACKET
GSC002/012	ED-ROMANIA	330657	LV UNDERGROUND CABLE 3x240+150N ALUMINUM CONDUCTOR XLPE INSULATION PO JACKET
GSC002/012	ED-ARGENTINA	0101-0488	LV UNDERGROUND CABLE 3x240+150N ALUMINUM CONDUCTOR XLPE INSULATION PO JACKET